

Anritsu envision : ensure

Signal Analyzer

MS2690A/MS2691A/MS2692A

MS2690A: 50 Hz to 6.0 GHz

MS2691A: 50 Hz to 13.5 GHz

MS2692A: 50 Hz to 26.5 GHz

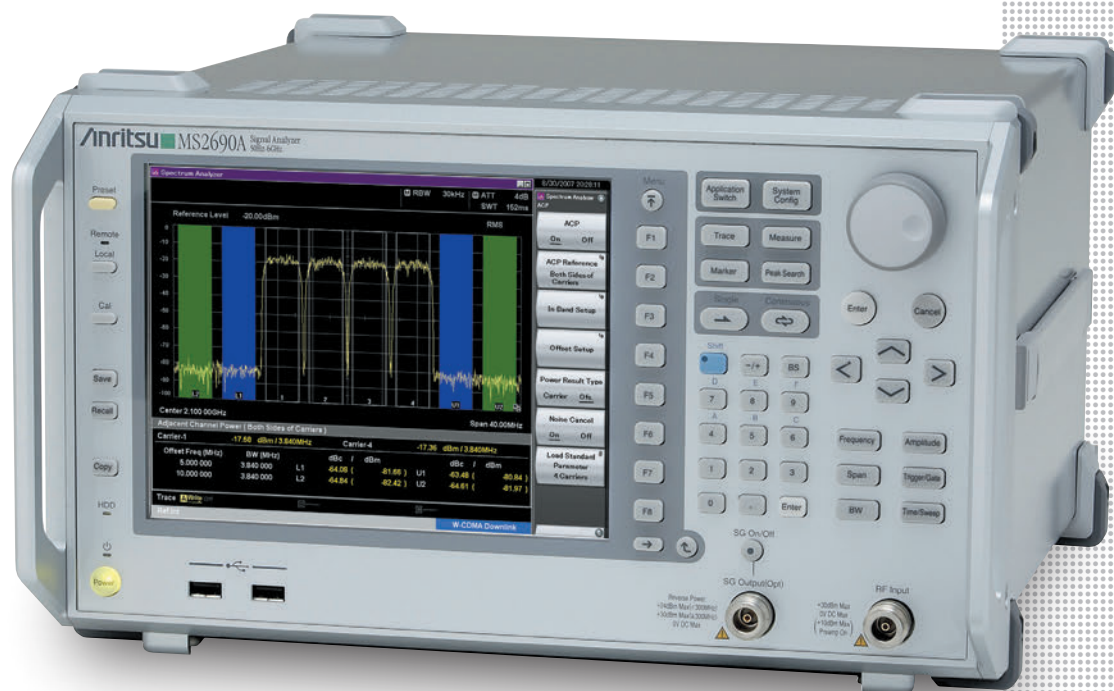

4TECT

OOO «4TECT»

Телефон: +7 (499) 685-4444

info@4test.ru

www.4test.ru





The Signal Analyzer MS2690A/MS2691A/MS2692A (MS269xA) has the excellent general level accuracy, dynamic range and performance of a high-end spectrum analyzer. Its easy operability and built-in functions are perfect for tests of Tx characteristics. Not only can it capture wideband signals but FFT technology supports multifunction signal analyses in both the time and frequency domains. Behavior in the time domain that cannot be handled by a sweep type spectrum analyzer can be checked in the frequency domain. A wide frequency can be analyzed using sweep type spectrum analysis functions while detailed signal analysis of a specific frequency band is supported too. Moreover, the built-in signal generator function outputs both continuous wave (CW) and modulated signals for use as a reference signal source when testing Tx characteristics of parts and as a signal source for evaluating Rx characteristics.

Wireless communications are tending toward use of higher frequencies above 3 GHz and wider bandwidths. However, general-purpose spectrum analyzers suffer from a degraded noise floor above 3 GHz due to the 3-GHz baseband, so they cannot be used to verify the true product performance. Because the MS269xA baseband can be extended up to 6 GHz it offers excellent level accuracy and modulation precision at frequencies from 50 Hz to 6 GHz. Adding the full line of versatile analysis software options eliminates the need for an external PC at wireless modulation analysis. Moreover, installing a preselector bypass option (MS2692A-067) enables use of the signal analyzer and modulation analysis functions up to 26.5 GHz (MS2692A). Waveform creation software generates modulation signal patterns for all common wireless technologies to output signals for the vector signal generator function.

The high-performance, multi-function MS269xA Signal Analyzer supports better analysis than more expensive standalone spectrum analyzers.

MS2690A/MS2691A/MS2692A

Signal Analyzer

- MS2690A: 50 Hz to 6.0 GHz
- MS2691A: 50 Hz to 13.5 GHz
- MS2692A: 50 Hz to 26.5 GHz



Key Features

Basic Performance/Functions

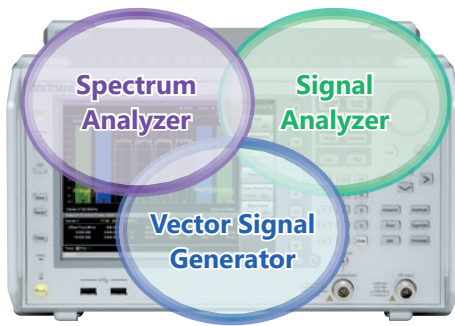

Frequency Range

MS2690A: 50 Hz to 6.0 GHz

MS2691A: 50 Hz to 13.5 GHz

MS2692A: 50 Hz to 26.5 GHz

Total Level Accuracy: ± 0.3 dB (typ.)

The Absolute Amplitude Accuracy specification described in catalogs of other spectrum analyzers ignores the important frequency characteristics, linearity, and attenuator switching errors. The MS269xA calibration technology supports excellent level accuracy over the wide frequency range from 50 Hz to 6 GHz even under measurement conditions including the above three errors.

Dynamic Range*1: 177 dB

TOI*2: $\geq +22$ dBm

DANL*3: -155 dBm/Hz

Improved Level Linearity

Internal Reference Oscillator

Pre-installed Reference Oscillator

Aging Rate: $\pm 1 \times 10^{-9}$ /day

Start-up Characteristics: $\pm 5 \times 10^{-8}$ (5 minutes after power-on)

Rubidium Reference Oscillator (MS269xA-001/037)

Aging Rate: $\pm 1 \times 10^{-10}$ /month

Start-up Characteristics:

$\pm 1 \times 10^{-9}$ (MS269xA-001: 7 minutes after power-on,

MS269xA-037: 15 minutes after power-on)

Versatile Built-in Functions

[Standard]

- Channel Power
- Occupied Bandwidth
- Adjacent Channel Leakage Power
- Spectrum Emission Mask*4
- Spurious Emission*4
- Burst Average Power
- Frequency Counter*4
- AM Depth*5
- FM Deviation*5
- Multi-marker & Marker List
- Highest 10 Markers
- Limit Line*4
- 2-tone 3rd-order Intermodulation Distortion*4
- Phase Noise
- Power Meter*6

[Option]

- Noise Figure*7

Signal Analyzer Functions

Analysis Bandwidth

Standard: 31.25 MHz max.

(50 MHz max. sampling rate = 20 ns resolution, ADC resolution 16 bits)
MS269xA-077: 62.5 MHz max.

(100 MHz max. sampling rate = 10 ns resolution, ADC resolution 14 bits)
MS269xA-078*8, *9: 125 MHz max.

(200 MHz max. sampling rate = 5 ns resolution, ADC resolution 14 bits)

Capture Function

Saves analysis Span \times Time signal to internal memory and writes to hard disk.

Up to 100 Msamples per measurement can be saved to internal memory.

Examples: Span 1 MHz: Max. capture time 50 s

Span 10 MHz: Max. capture time 5 s

Span 100 MHz: Max. capture time 0.5 s

Replay Function

Reads saved data and replays using signal analyzer function.

Examples:

1. Data sharing between separate R&D and manufacturing
2. Later laboratory bench-top analysis of on-site signals

Measurement with Sub-trace Display

Splits screen and confirms both main and sub-traces at same time to check errors.

Main: Spectrum, Frequency vs. Time, Power vs. Time,

Phase vs. Time, CCDF/APD, Spectrogram

Sub: Power vs. Time, Spectrogram

Supports 125 MHz Wideband Measurements up to 26.5 GHz

Microwave Preselector Bypass MS269xA-067 *10

Analysis Bandwidth Extension to 125 MHz MS269xA-078 *8

Bypassing preselector improves RF frequency characteristics and in-band frequency characteristics. Supports modulation analysis and signal analyzer measurements for signals up to 26.5 GHz.

Vector Signal Generator (MS269xA-020)

Frequency Range: 125 MHz to 6 GHz

Pre-installed Baseband Generator

Vector Modulation Bandwidth: 120 MHz

Sampling Clock: 20 kHz to 160 MHz

Level Accuracy: ± 0.5 dB

Large-capacity Memory: 1 GB = 256 Msamples

Internal AWGN Generator

Internal BER Measurement Function

Bit Rate: 100 bps to 10 Mbps

Input Level: TTL

*1: Difference between TOI and DANL as simple guide

*2: TOI (Third Order Intercept)

*3: DANL (Displayed Average Noise Level)

*4: Spectrum Analyzer Functions

*5: Signal Analyzer Functions

*6: Use USB Power Sensors

*7: Noise Figure Measurement Function (Requires MS269xA-017)

[Use Noise Sources (Noisecom, NC346 series)]

*8: Requires MS269xA-077

*9: Combining with MX269028A-002 wireless LAN IEEE 802.11ac (160 MHz)

measurement software (only for MS269xA) supports modulation analysis up to 160-MHz bandwidth signals of the IEEE 802.11ac.

See measurement software catalog for more details.

*10: MS269xA-067 can be installed in MS2692A

Panel Layout

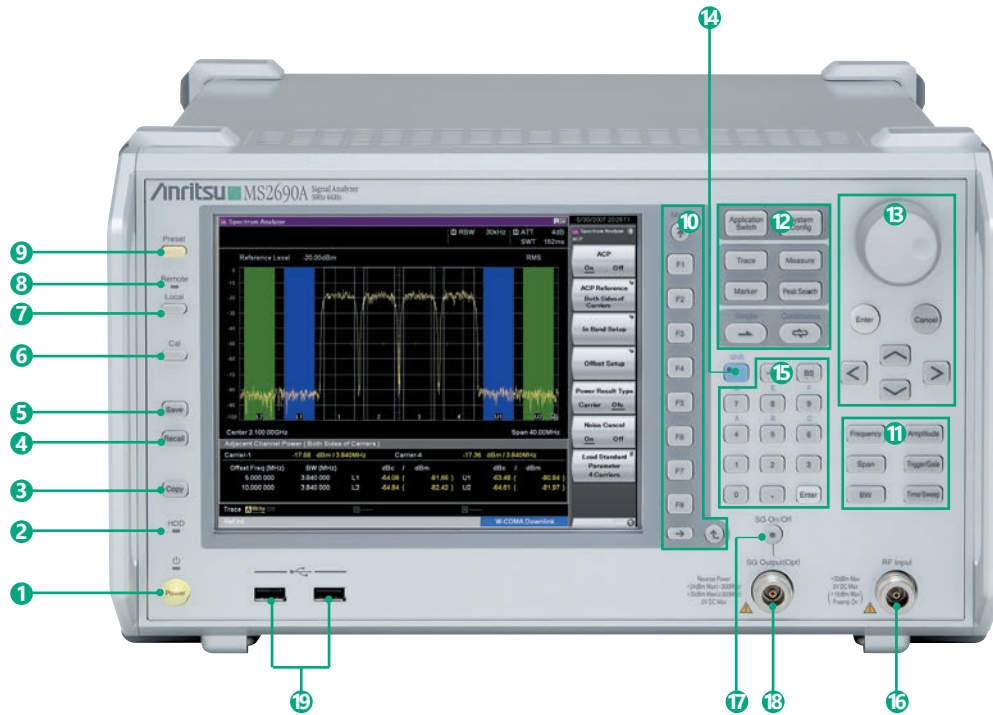

1 Power switch

Press to switch move between the standby state in which AC power is supplied and the Power On state in which the MS269xA in the operating mode.

2 Hard disk access lamp

Lights up when the MS269xA internal hard disk is being accessed.

3 Copy key

Press to capture a screen image from the display and save it to a file.

4 Recall key

Press to recall a parameter file.

5 Save key

Press to save a parameter file.

6 Cal key

Press to display the calibration execution menu.

7 Local key

Press to return to local operation from remote control operation through GPIB, Ethernet or USB (B), and enable panel settings.

8 Remote lamp

Lights up when the MS269xA is in a remote control state.

9 Preset key

Resets parameters to their initial settings.

10 Function keys

Used for selecting or executing function menu displayed on the right of the screen.

11 Main function keys 1

Used to set or execute main functions of the MS269xA. Executable functions vary depending on the application currently selected.

12 Main function keys 2

Used to set or execute main functions of the MS269xA. Executable functions vary depending on the application currently selected.

13 Rotary knob/Cursor key/Enter key/Cancel key

The rotary knob and cursor keys are used to select display items or change settings.

14 Shift key

Used to operate any keys with functions described in blue characters on the panel. First press the Shift key, then press the target key when the Shift key lamp lights up green.

15 Numeric keypad

Used to enter numbers on parameter setup screens.

16 RF Input connector

Inputs an RF signal.

17 RF output control key

If the MS269xA-020 Vector Signal Generator is installed, pressing enables (On) or disables (Off) the RF signal output. The lamp of the RF output control key lights up orange when the RF signal output is set to On.

18 RF output connector (when MS269xA-020 installed)

Outputs an RF signal.

19 USB connectors (type A)

Used to connect a USB keyboard or mouse or the USB memory supplied with the MS269xA.

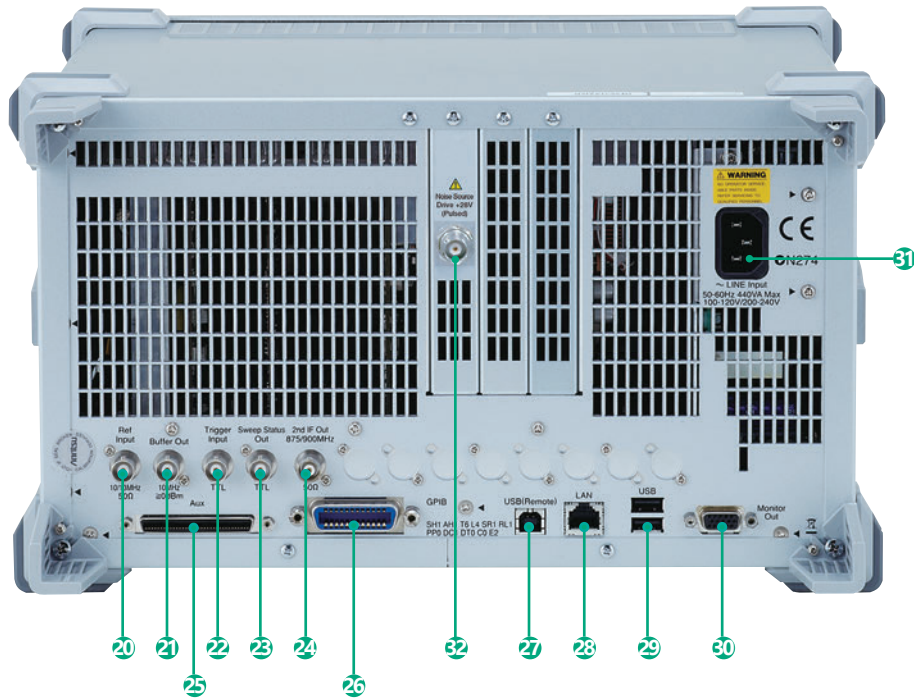

20 Ref Input connector

(reference frequency signal input connector)

Inputs an external reference frequency signal (10 MHz/13 MHz). It is used for inputting reference frequency signals with accuracy higher than that of those inside the MS269xA, or for synchronizing the frequency of the MS269xA to that of another device.

21 Buffer Out connector

(reference frequency signal output connector)

Outputs the reference frequency signal (10 MHz) generated inside the MS269xA. It is used for synchronizing the frequencies between other devices and the MS269xA based on the reference frequency signal output from this connector.

22 Trigger Input connector

Inputs a trigger signal from an external device. Refer to the operation manual of each application for operations when a trigger signal is input.

23 Sweep Status Out connector

Outputs a signal that is enabled when an internal measurement is performed or measurement data is obtained.

24 IF Out connector

Outputs an IF signal. 874.988 MHz is specified as the center frequency during spectrum analyzer operations, and 875 or 900 MHz is specified during signal analyzer operations. (Bandwidth ≤ 31.25 MHz: 875 MHz, Bandwidth > 31.25 MHz: 900 MHz)

The IF signal is output without band limitation by RBW during both spectrum analyzer and signal analyzer operations.

25 Aux connector

Composite connector for Vector Signal Generator options with Marker 1 to 3 outputs, pulse modulation input, baseband reference clock signal input, and BER measurement Clock, Data, and Enable inputs. Converted to BNC using optional AUX Conversion Adaptor (J1373A).

26 GPIB connector

Used when controlling the MS269xA externally via GPIB.

27 USB connector (type B)

Used when controlling the MS269xA externally via USB.

28 Ethernet connector

Used for connecting to a personal computer (PC) or for Ethernet connection.

29 USB connectors (type A)

Used to connect a USB keyboard or mouse or the USB memory supplied with the MS269xA.

30 Monitor Out connector

Used for connection with an external display.

31 AC inlet

Used for supplying power.

32 Noise Source Drive connector

This is available when the MS269xA-017/117 is installed. Supply (+28 V) of the Noise Source Drive.

Basic Performance

Excellent Total Level Accuracy: ± 0.3 dB (typ.)

(Common to both Spectrum Analyzer and Signal Analyzer Functions)

With a 6-GHz basic band and level calibration over a wide frequency range, the MS269xA has excellent total level accuracy. The Absolute Amplitude Accuracy specification described in catalogs of other spectrum analyzers ignores the important frequency characteristics, linearity, and attenuator switching errors. In contrast, the MS269xA Level Calibration technology assures excellent level accuracy over a wide frequency range from 50 Hz to 6 GHz even under measurement conditions including the above three errors. The level accuracy is assured even when the frequency and attenuator are switched.

Advantage of 6 GHz Basic Band

Conventional spectrum analyzers have a degraded noise floor above 3 GHz because they use a preselector at the 3-GHz basic band, which causes lowered measurement accuracy. The MS269xA basic band of 6 GHz eliminates the degraded noise floor and improves measurement accuracy.

Advantage of MS269xA Level Accuracy Technology

Conventional spectrum analyzers perform level calibration at just one frequency point, which causes errors when the frequency changes. The MS269xA has two built-in signal generators for level calibration over a wide frequency range from 50 Hz to 6 GHz, minimizing measurement errors in this frequency range.

The MS269xA total level accuracy includes:

- Frequency characteristics
- Linearity
- Attenuator switching error

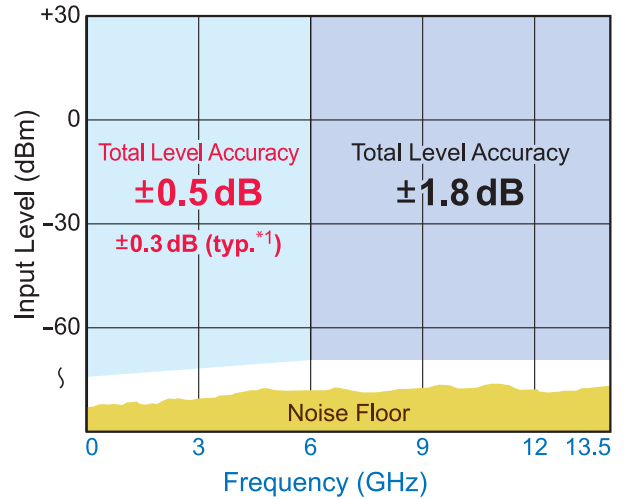

Note: Eliminates effect of noise floor
Used only when Uncal does not occur

*1: Excluding Guard Band

MS269xA Block Diagram

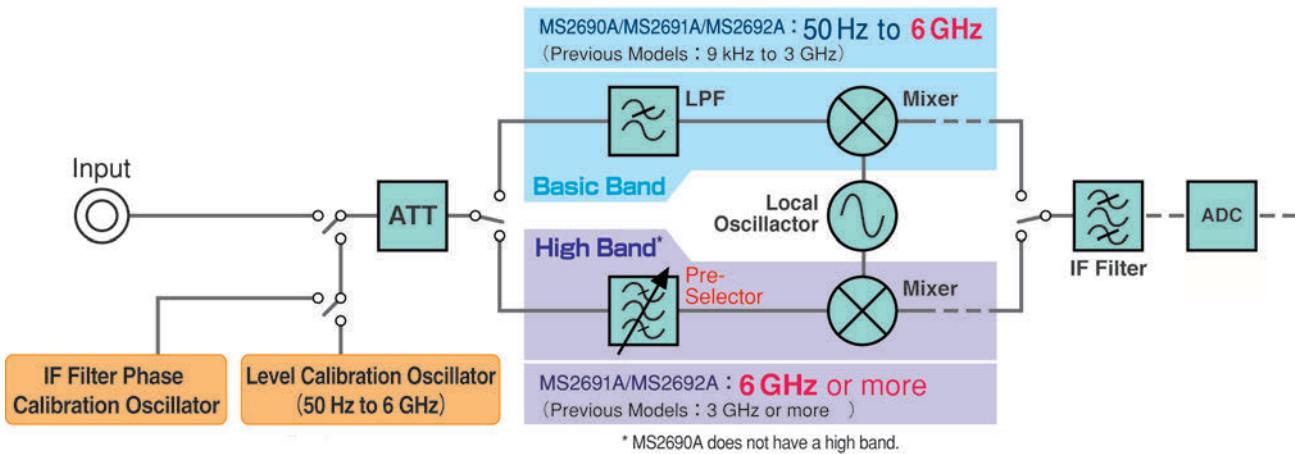

Preselector

The MS269xA has a basic band that goes to 6 GHz without a preselector. Most spectrum analyzers may use a preselector in the high band to clean-up images but it is extremely difficult to stabilize the amplitude and frequency characteristics of the preselector. This instability is the main cause of degraded level accuracy and modulation precision in measuring instruments.

Additionally, the preselector passband frequency can cause limitations at analysis bandwidths. No preselector means greater measurement accuracy.

Microwave Preselector Bypass MS2692A-067*

Bypasses the preselector to improve the RF frequency characteristics and the in-band frequency characteristics. When the preselector option is set to On, the image response elimination filter is bypassed. Therefore, this function is not appropriate for spurious measurement to receive the image response.

*: MS269xA-067 can be installed in MS2692A.

Basic Performance

Example: Level Error Comparison with Different Level Calibration Method

MS269xA

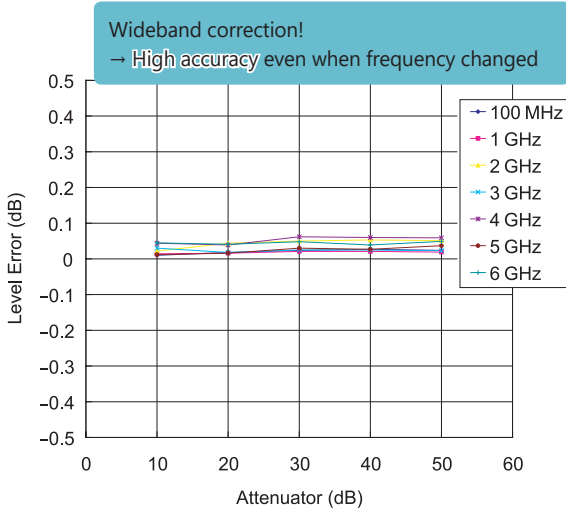

Conventional Spectrum Analyzer

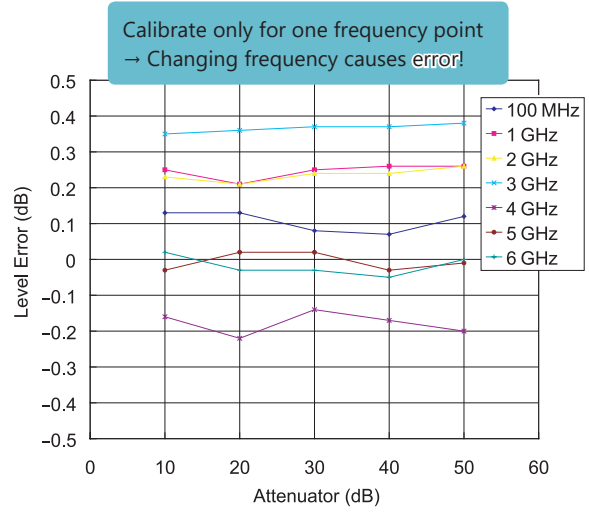

The MS269xA total level accuracy includes:

- Frequency characteristics
- Linearity
- Attenuator switching error

The absolute amplitude accuracy specifications of other spectrum analyzers excludes:

- Frequency characteristics
- Linearity
- Attenuator switching error

The measuring instrument level error cannot be said to really meet the specifications if measurement requires addition of a margin to the product test specification. Since specifications with added margin are severe, even genuinely passing products may sometimes be evaluated as failing due to this margin.

Level accuracy

Good

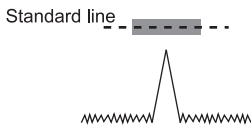

Bad

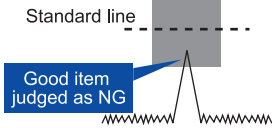

■ : Margin of measurement instrument level accuracy

Dynamic range

Wide

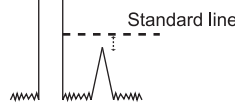

Narrow

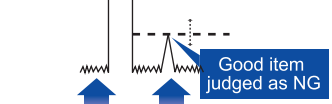

Noise floor raise causes measurement value rise and unstable noise power!

cause

1. Bad displayed average noise level
2. Bad TOI
→ Large ATT required to prevent distortion by high-power input

Basic Performance

Top Class Dynamic Range

Dynamic range*1: 177 dB

TOI*2: $\geq +22$ dBm (700 MHz to 4 GHz)

DANL*3: -155 dBm/Hz (30 MHz to 2.4 GHz)

*1: Difference between TOI and DANL as simple guide.

*2: TOI (Third Order Intercept)

*3: DANL (Displayed Average Noise Level)

Dynamic range is a key specification for spectrum analyzers. Low displayed average noise level (DANL) as well as high TOI are important too. Low TOI may cause distortion with high-level carrier signals. Inserting an attenuator can lower the carrier level but this has the effect of lowering the level of weak spurious, making it hard to measure.

The MS269xA has an excellent dynamic range supporting true performance measurements of devices, such as base stations, requiring wideband measuring instruments.

For example, the 3GPP category-B spurious measurement specification requires a measuring instrument with severe dynamic range specifications. If the measurement is within the MS269xA dynamic range, measurement jigs such as filters and amplifiers are unnecessary and troublesome calibration is omitted, helping simplify setup and cut costs.

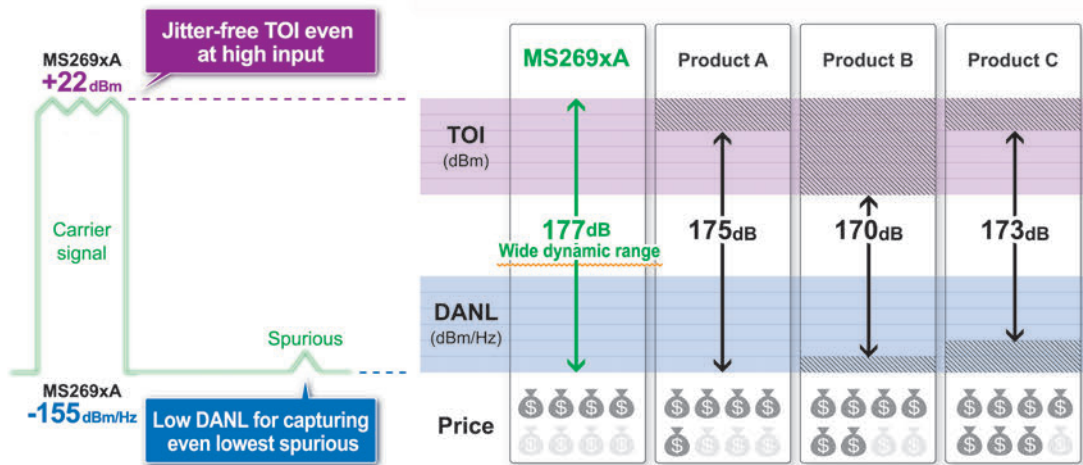

Distortion Characteristics (Spectrum Analyzer)

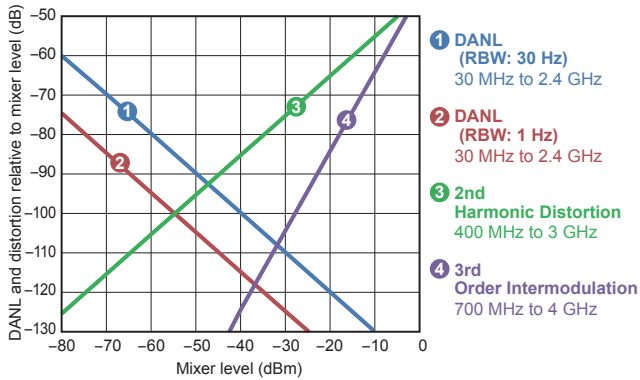

Example: SSB Phase Noise (Spectrum Analyzer/Signal Analyzer Common)

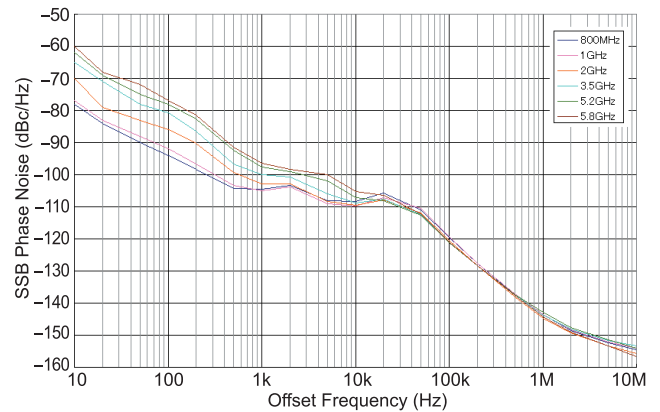

Basic Performance

Supports 125 MHz Wideband Measurements up to 26.5 GHz

Microwave Preselector Bypass MS2692A-067*1 + Analysis Bandwidth Extension to 125 MHz MS2692A-078*2

*1: Can be installed in MS2692A.

*2: Require MS2692A-077.

Supports wideband analysis with high frequencies for satellite communications

Microwave preselector bypass frequency range: 6 GHz to 26.5 GHz (MS2692A)

Installing the microwave preselector bypass supports signal analyzer measurement functions in the above frequency range.

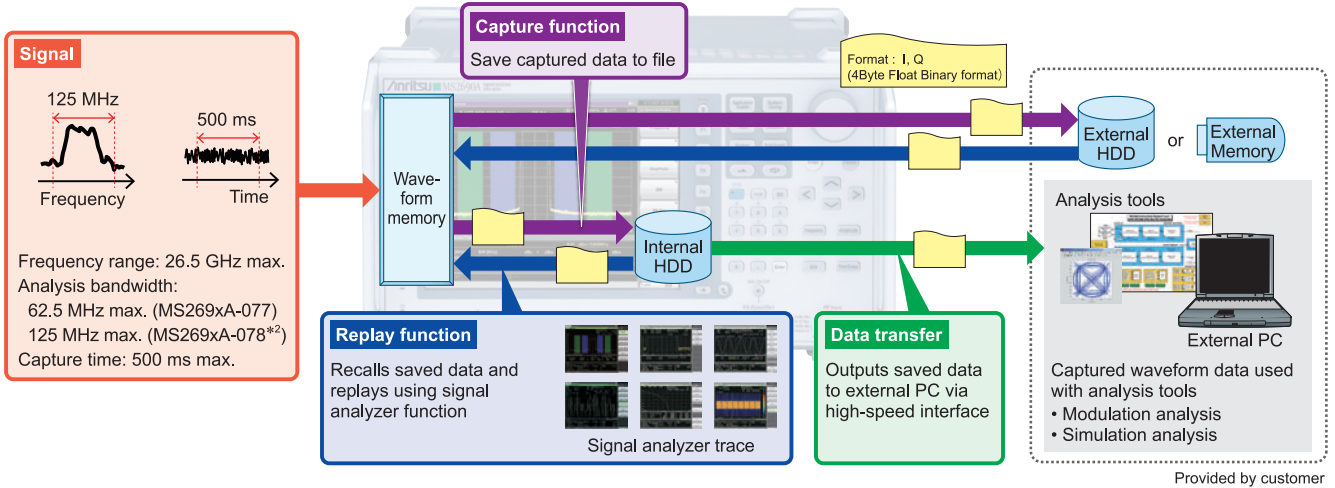

Improved Level Linearity

Conventional spectrum analyzers use an analog IF and log amp to achieve good level accuracy at points near the log scale reference level, but the accuracy degrades at points that are further away.

The MS269xA uses a digital IF instead of a log amp, which supports measurements with excellent accuracy at any point.

Example: Level Stability by Switching Reference Level

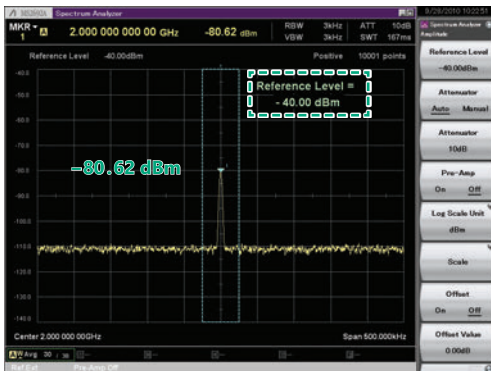
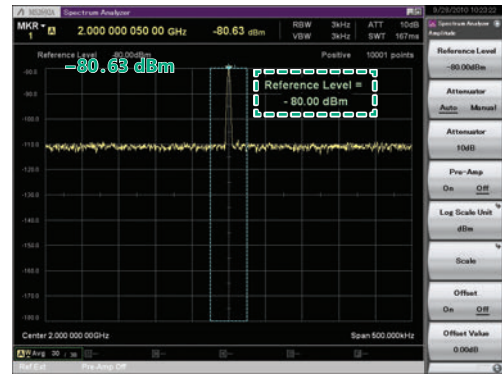
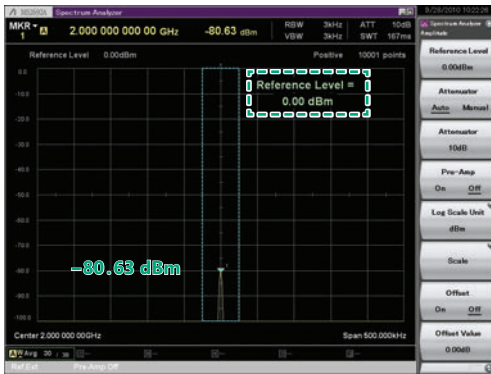

Level Linearity:

The MS269xA total level accuracy is better than that of conventional spectrum analyzers but sometimes a power meter is used when wanting to measure with even higher accuracy. However, use of a power meter narrows the dynamic range and errors may also occur easily when switching the power range. Since a power meter has no frequency selection, the total power of the input signal is measured. In other words, the power of the target frequency components cannot be separated out. Measurement can be performed with a wide dynamic range after checking the MS269xA level measurement reference value with a power meter.

The MS269xA total level accuracy includes:

- Frequency characteristics
- Linearity
- Attenuator switching error

And supports excellent:

- Log scale stability

Basic Performance

Dual Sweep Speed: Normal/Fast

When sweep time is set to [Auto], Normal (normal sweep) or Fast mode (high-speed sweep) can be set. The Fast mode sweeps six times faster than the Normal mode.

Example of Sweep Mode Switch Error: (CW -10 dBm input)
Level Error when Switching from Normal to Fast

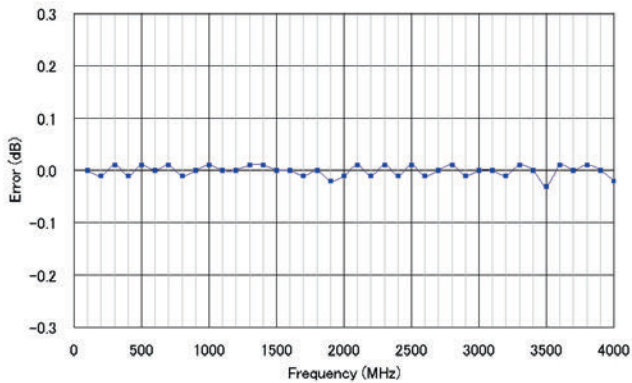

Resolution Bandwidth (RBW)

Setting Range (Spectrum Analyzer):

30 Hz to 3 MHz (1-3 sequence),
50 kHz, 5 MHz, 10 MHz, 20 MHz, 31.25 MHz*1

Setting Range (Spectrum trace in signal analyzer mode):

1 Hz to 1 MHz (1-3 sequence), 3 MHz*2, *3, 10 MHz*3

When monitoring two adjacent signals, the frequency resolution can be increased by reducing the resolution bandwidth (RBW).

This also has the effect of reducing the noise level.

Conversely, to confirm level variations of 20-MHz band signals such as LTE, set the RBW to 31.25 MHz.

*1: Instead of Gaussian filter, 31.25 MHz RBW uses filter with flat top characteristics above 31.25 MHz.

*2: With MS269xA-077 installed and bandwidth setting ≥ 50 MHz

*3: With MS269xA-077+078 installed and bandwidth setting ≥ 50 MHz

Trigger Function

Trigger sweep executes sweeping using the specified trigger condition as the start point. In particular, "SG Marker" starts analyzer measurement in synchrony with the signal output by installing MS269xA-020. Using this function supports simple synchronized measurement even when evaluating signals with large level variation over time, such as modulation signals.

- Video trigger:
Trigger sweeping starts in synchronization with the rise or fall of the waveform. A trigger level indicator showing the trigger level is displayed on the screen.
- Wide IF video trigger:
An IF signal with a wide passing band of about 50 MHz is detected, and sweeping starts in synchronization with either the rise or fall of the detected signal.
- External trigger:
Sweeping starts in synchronization with the rise or fall of the signal input via the Trigger Input connector.
- SG Marker trigger (Requires MS269xA-020):
Sweeping starts in synchronization with the rise or fall of the marker signal output of MS269xA-020. This function supports measurement in synchronization with the output signal of MS269xA-020.

Gate Sweep

Gate sweep executes sweeping only for the length of time specified by the gate length, starting from when the trigger condition is met. A delay time until sweeping starts after the trigger condition is met can be set using trigger delay.

- The gate source can be selected from the following
 - Wide IF video trigger
 - External trigger
 - SG marker trigger (Requires MS269xA-020)
- Setting range and resolution for gate delay
 - Setting range: 0 to 1 s
 - Resolution: 20 ns
- Setting range and resolution for gate length
 - Setting range: 50 μ s to 1 s
 - Resolution: 20 ns

Three Built-in External Interfaces

The built-in Gigabit Ethernet, USB2.0, and GPIB interfaces support remote operation.

GPIB: IEEE 488.2, Rear panel, IEEE 488 bus connector

Interface functions: SH1, AH1, T6, L4, SR1, RL1, PP0, DC1, DT0, C0, E2

Ethernet: 10/100/1000BASE-T, Rear panel, RJ-45

USB (B): USB2.0, Rear panel, USB-B connector

Saving Measurement Results

Measurement results can be saved to internal hard disk or external USB memory. Screen dumps and trace data can be saved too.

- Screen dump file type
 - BMP
 - PNG
- The color of the screen hard copy can be set as follows:
 - Normal (same as screen display)
 - Reverse
 - Monochrome
 - Reversed Monochrome

Signal Analyzer: Basic Performance/Functions

Wide bandwidth × High Accuracy FFT Analysis

Standard: 31.25 MHz max.

(Sampling rate 50 MHz max = Resolution 20 ns,
ADC resolution 16 bits)

MS269xA-077: 62.5 MHz max.

(Sampling rate 100 MHz max = Resolution 10 ns,
ADC resolution 14 bits)

MS269xA-078*1,*2: 125 MHz max.

(Sampling rate 200 MHz max = Resolution 5 ns,
ADC resolution 14 bits)

Based on the excellent level accuracy and wide dynamic range of the MS269xA, a signal with an FFT analysis bandwidth of up to 125 MHz can be captured with a level accuracy of ± 0.3 dB.

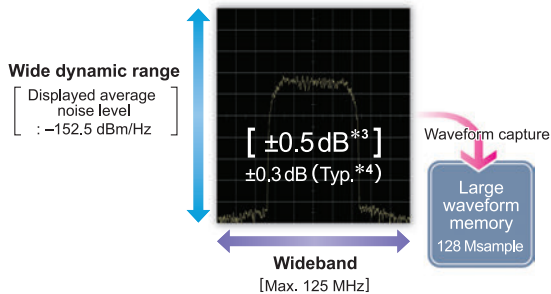

*1: Requires MS269xA-077

*2: Combining with MX269028A-002 wireless LAN IEEE 802.11ac (160 MHz) measurement software (only for MS269xA) supports modulation analysis up to 160-MHz bandwidth signals of the IEEE 802.11ac.

See measurement software catalog for more details.

*3: 50 Hz ≤ Frequency ≤ 6.0 GHz, Frequency band mode: Normal

*4: Excluding Guard Band

Excellent Frequency Characteristics in Analysis Bandwidth

The Signal Analyzer Extra Band Cal function using the built-in oscillator for calibration supports analysis bandwidth calibration at the set frequency. The excellent in-band frequency characteristics support wideband modulation analysis with less error.

Extra Band Cal Frequency Range

Span ≤ 31.25 MHz (Standard): 30 MHz to 6 GHz

Span > 31.25 MHz (MS269xA-077/078): 100 MHz to 6 GHz

*: Setting center frequency after Extra Band Cal, requires re-execution of Extra Band Cal.

Example of frequency characteristics in analysis bandwidth after Extra Band Cal (With MS269xA-078, Reference Level: -10 dBm, Input attenuator: 10 dB, Preamp: Off, Span: 125 MHz)

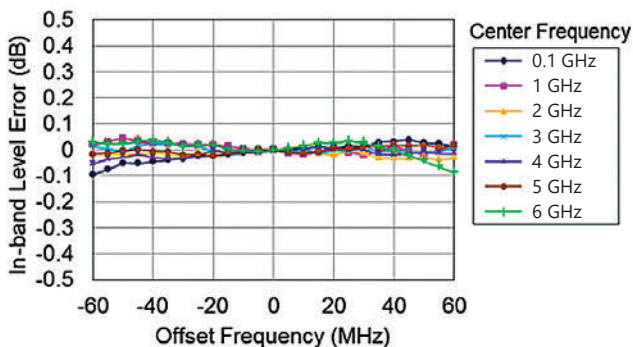

Save Signals in Internal Memory

Max. Capture Time: 0.5 s to 2000 s

Max. Number of Samples: 100 Msamples

The “Analysis bandwidth × Analysis time” signal is held in internal memory and saved to hard disk.

Up to 100 Msamples of data can be saved to memory for one measurement. The frequency span determines the sampling rate. The following chart shows the maximum capture time per frequency span.

Span	Sampling Rate	Capture Time	Max. Sampling Data
1 kHz	2 kHz	2000 s	4M
2.5 kHz	5 kHz	2000 s	10M
5 kHz	10 kHz	2000 s	20M
10 kHz	20 kHz	2000 s	40M
25 kHz	50 kHz	2000 s	100M
50 kHz	100 kHz	1000 s	100M
100 kHz	200 kHz	500 s	100M
250 kHz	500 kHz	200 s	100M
500 kHz	1 MHz	100 s	100M
1 MHz	2 MHz	50 s	100M
2.5 MHz	5 MHz	20 s	100M
5 MHz	10 MHz	10 s	100M
10 MHz	20 MHz	5 s	100M
25 MHz	50 MHz	2 s	100M
31.25 MHz	50 MHz	2 s	100M
50 MHz*	100 MHz	500 ms	50M
62.5 MHz*	100 MHz	500 ms	50M
100 MHz*	200 MHz	500 ms	100M
125 MHz*	200 MHz	500 ms	100M

*: With MS269xA-077: 50/62.5 MHz

With MS269xA-077/078: 50/62.5/100/125 MHz

Replay Function for Comparison Evaluation

This function reads saved data and replays it using the signal analyzer measurement function.

Examples:

1. Data sharing between separate R&D and manufacturing
2. Later laboratory bench-top analysis of on-site signals
3. Save data at shipment and re-verify if problem occurs

Captured Waveform Data: Selection Screen

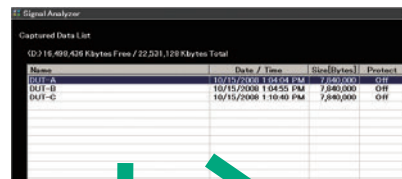

DUT (A)

DUT (B)

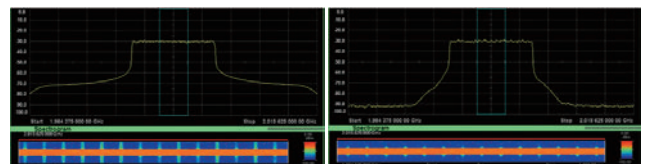

Spectrum

The Spectrum trace displays a graph with amplitude on the y-axis and frequency on the x-axis. The captured IQ data is FFT processed (fast Fourier transformed) and converted from the time domain to the frequency domain for display as a spectrum.

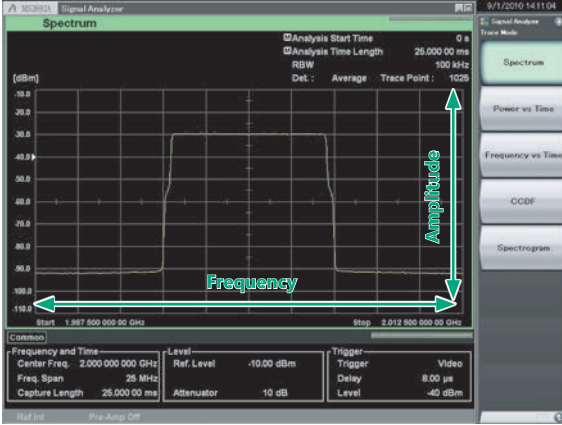

Phase vs. Time

The Phase vs. Time trace displays a graph with phase on the y-axis and time on the x-axis to confirm time variation of the measured signal phase.

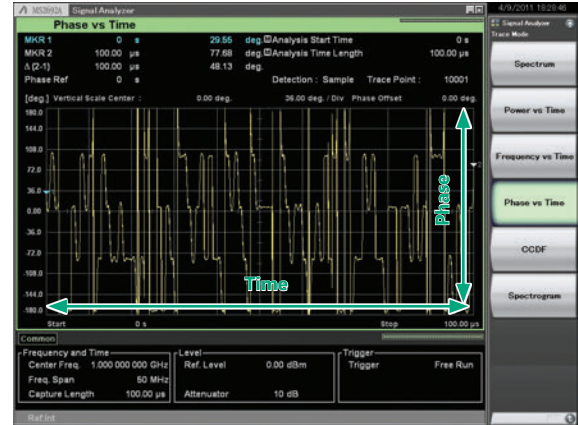

Power vs. Time

The Power vs. Time trace displays a graph with amplitude on the y-axis and time on the x-axis to confirm changes in power with time of measured signals.

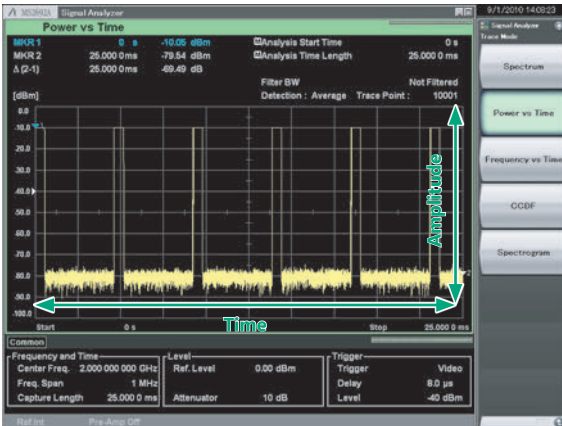

CCDF*1/APD*2

The CCDF trace displays the power variation probability on the y-axis and power variation on the y-axis to confirm the CCDF and APD of measured signals.

- *1: CCDF (Complementary Cumulative Distribution Function)
- *2: APD (Amplitude Probability Density)

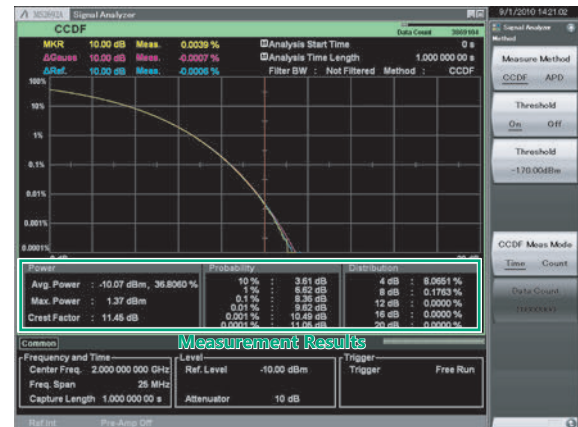

Frequency vs. Time

The Frequency vs. Time trace displays a graph with frequency on the y-axis and time on the x-axis to confirm time variation of the measured signal frequency.

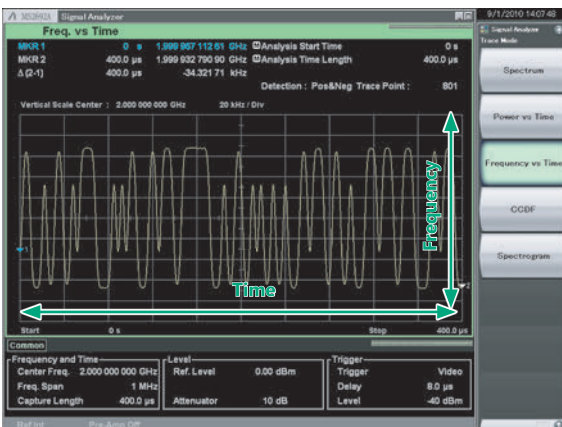

Measurement Results

- CCDF: The CCDF display indicates the cumulative distribution of transient power variations compared to average power.
- APD: The APD display indicates the probability distribution of transient power fluctuations compared to average power.

Signal Analyzer: Trace

Spectrogram

The Spectrogram trace displays the level as color with frequency on the y-axis and time on the x-axis. The captured IQ data is FFT processed to confirm time variations in the continuous spectrum. It is useful for monitoring frequency hopping and transient signals.

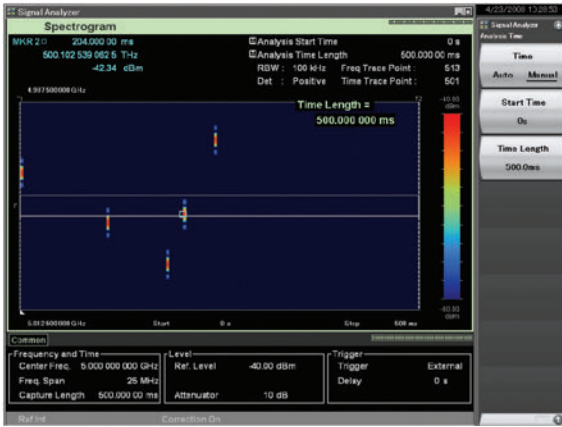

No Trace

No Trace mode does not execute signal analysis. Therefore, "IQ data output" and "IQ data readout using remote commands" can be executed quickly without the need to wait for completion of analysis.

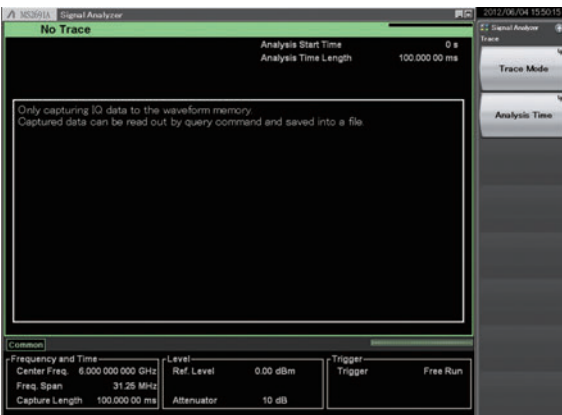

Measurement with Sub-trace Display

This function splits the screen into top and bottom halves; simultaneous display of the sub-trace supports easy monitoring of fault locations and transient phenomena.

Main: Spectrum, Frequency vs. Time, Power vs. Time, Phase vs. Time, CCDF/APD, Spectrogram

Sub: Power vs. Time, Spectrogram

The part of a previously captured long-term signal to be monitored can be selected (Blue part) on the sub-trace to display the problem part only on the main trace.

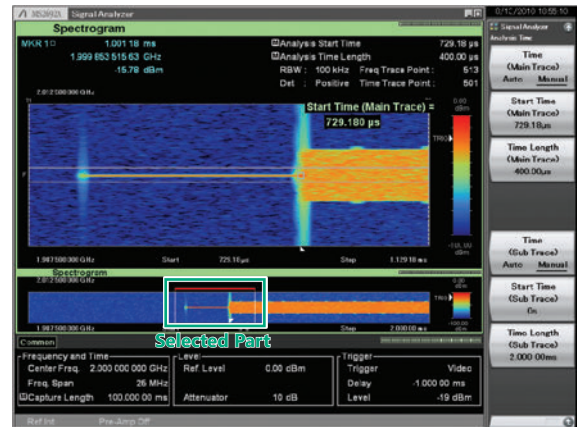

Example: Sub-trace Display

Confirm analysis range in sub-trace, and target signal status on main trace.

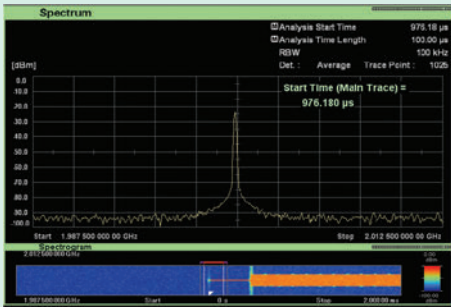

↑ Analysis range

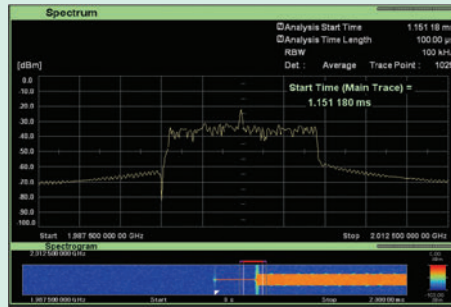

↑ Analysis range

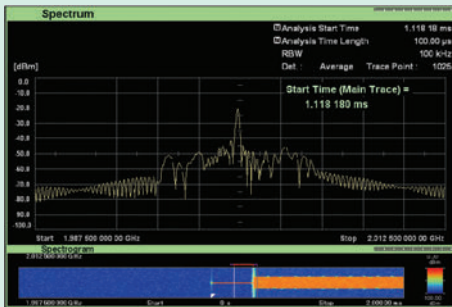

↑ Analysis range

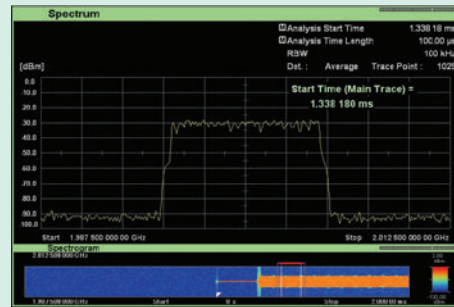

↑ Analysis range

Signal Analyzer: Applications

Analyze Captured Waveforms using Third-Party Tools

The MS269xA utilizes proprietary calibration technologies, enabling digitized baseband data to be used directly in third-party analysis tools without the need for correction.

Capture & Playback Real-World Signals

The MS269xA provides *Capture & Playback* functionality that enables laboratory-grade testing of transceiver systems using real world signals. Using the optional integrated Vector Signal Analyzer and Vector Signal Generator of the MS269xA, *Capture & Playback* allows users to conveniently capture up to 100 MHz of spectrum and play it back at any designated frequency and amplitude, making it easy to determine device performance margins.

Applications for Capture & Playback

Validation/Production Test

Captured signals can be used to initiate a communications link and perform receiver sensitivity testing with a device under test (DUT) using signals captured from a Golden Unit.

Device Characterization

Actual baseband signals captured from an RFIC can be used as simulation for characterizing amplifiers and other downstream devices or modules.

Electromagnetic Compatibility Test

Problematic RF environments or discrete signals – such as cellular or Wi-Fi – can be captured and used to evaluate a device’s susceptibility to RF interference, debug any problems found and validate the solution

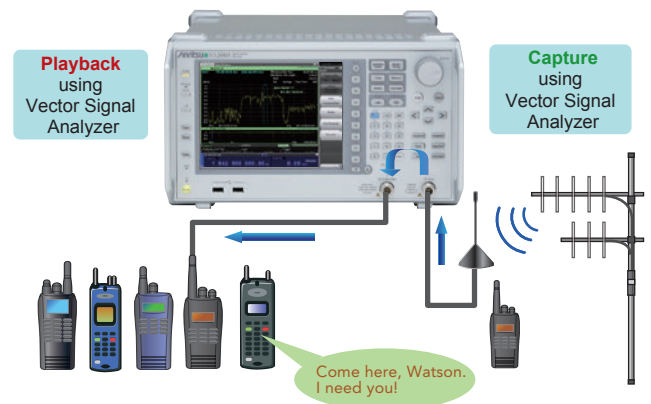
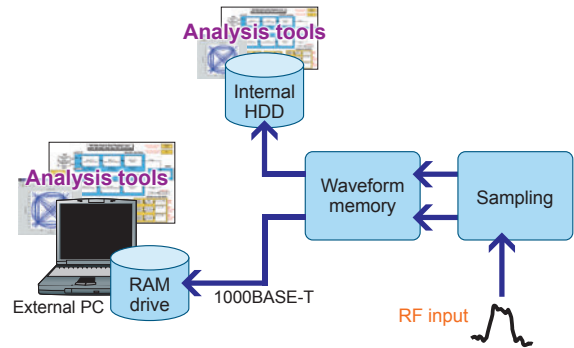

Repeatably Test Device Performance using “Real-World” RF Environments

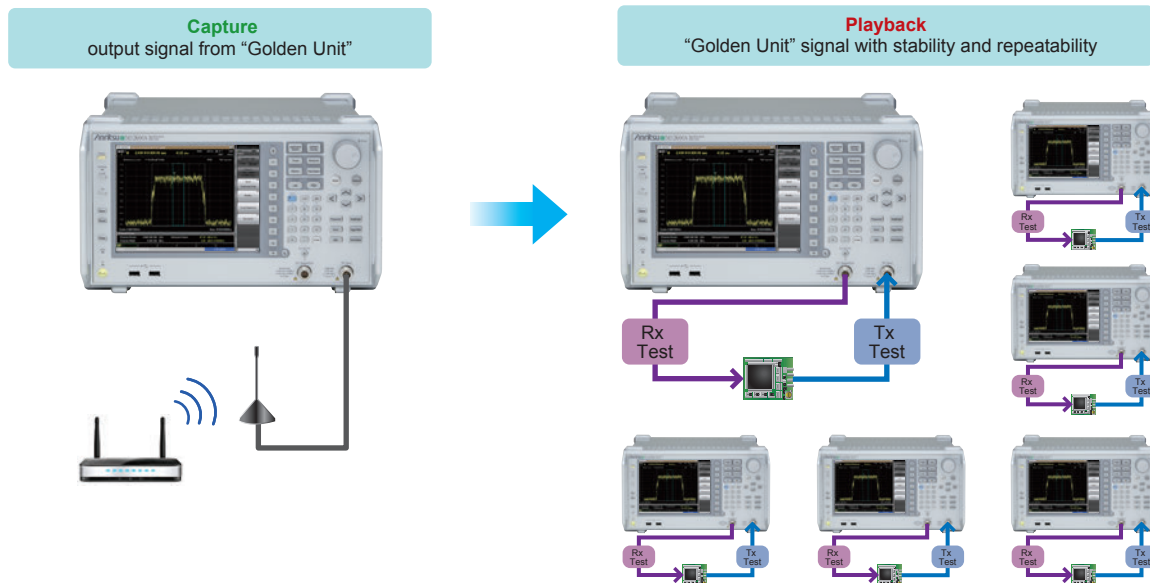

Use “Golden Unit” Signal for Manufacturing Test and Calibration

Signal Analyzer: Applications

Capture & Playback Highlights

- Bandwidth and Time Limits
 - Minimum 10 kHz Bandwidth (2000 s maximum duration)*
 - Maximum 100 MHz Bandwidth (500 ms maximum duration)*
- *: Maximum bandwidth depends upon vector signal analyzer options installed (Standard analysis bandwidth or MS269xA-077/078).
- Captured signal may be freely tuned to any output frequency and amplitude supported by the vector signal generator.
- Any section of the captured waveform record may be selected and played back.
 - Enables user to isolate and reproduce specific signal bursts
 - Enables user to change duty cycle of pulsed waveforms

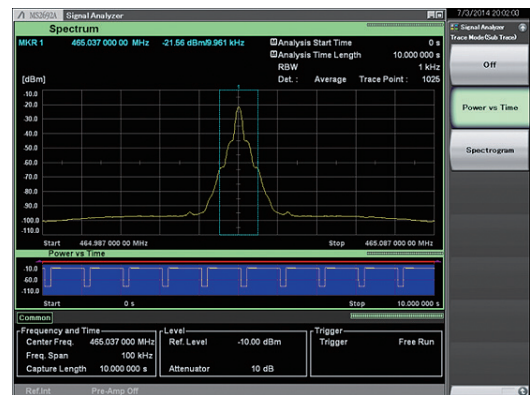
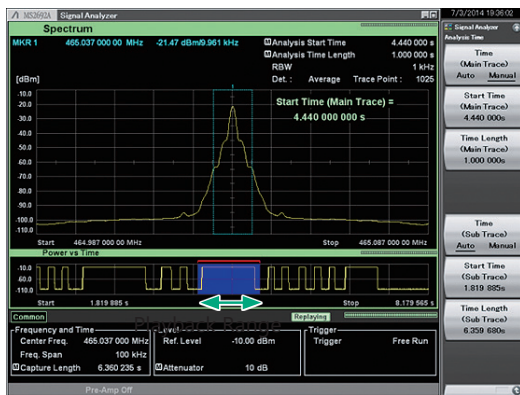
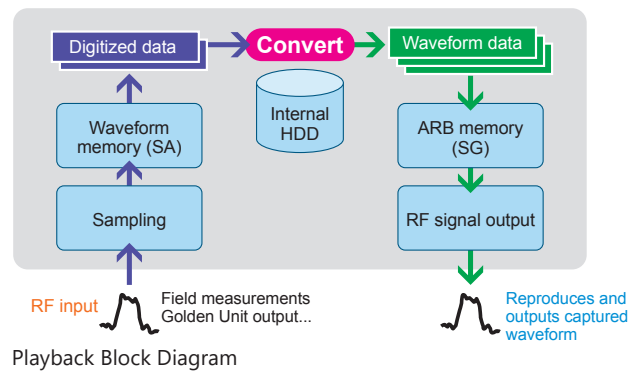

Playback any Desired Section of Captured Waveform

Example: Noise Analysis and Record and Replay

Signal Analyzer Capture Function Records Noise

- Save frequency span × Capture time as data file in memory
- Re-sample saved data and output as file to internal or external hard disk
- Recall data saved in internal or external hard disk and analyze as many times as necessary
- Perform multi-domain analysis, such as frequency axis, time axis, spectrogram, etc.

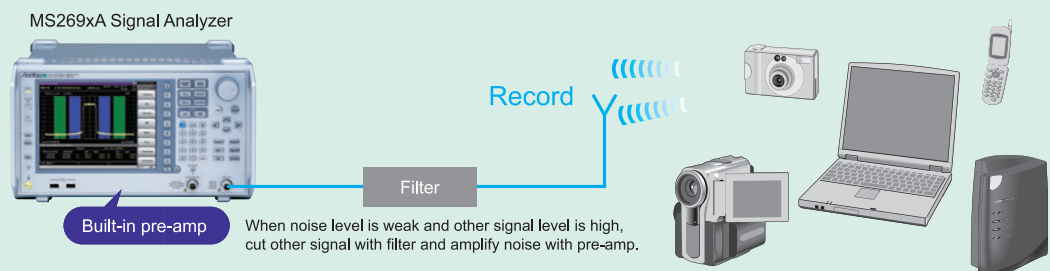

Replay Captured Noise from Vector Signal Generator

- Vector Signal Generator generates waveform pattern using built-in PC based on data captured by Signal Analyzer
- Outputs generated waveform at arbitrary level and frequency → Replay noise
- Simple Capture & Playback function key operations support easy capture through to noise regeneration

MS269xA Signal Analyzer + MS269xA-020 Vector Signal Generator (option)

- Built-in PC
- Built-in Vector Signal Generator



MS269xA-020 Vector Signal Generator

- Frequency Range: 125 MHz to 6 GHz
- Output Level: -140 to 0 dBm
- Baseband Generator Clock: 20 kHz to 160 MHz
- Arbitrary Waveform Memory: 1 GB

Versatile Built-in Functions

Useful for Tx Characteristics Evaluation

The MS269xA is fully loaded with all the functions required for evaluating Tx characteristics. Tests can be performed simply and in accordance with standards using functions tailored to measurement contents.

Measure Function	SPA*1	VSA*2
Channel Power	✓	✓
Occupied Bandwidth	✓	✓
Adjacent Channel Leakage Power	✓	✓
Spectrum Emission Mask	✓	✓
Burst Average Power	✓	✓
Spurious Emission	✓	
AM Depth		✓
FM Deviation		✓
Multi-marker & Marker List	✓	✓
Highest 10 Markers	✓	✓
Limit Line	✓	
Frequency Counter	✓	
2-tone 3rd-order Intermodulation Distortion	✓	
Annotation Display (On/Off)	✓	
Phase Noise	Independent function	
Power Meter	Independent function*3	
Noise Figure	MS269xA-017*4	

- *1: SPA (Spectrum Analyzer)
- *2: VSA (Vector Signal Analyzer)
- *3: Use USB Power Sensors
- *4: Use Noise Sources (Noisecom, NC346 series)

Channel Power

SPA VSA

This function measures channel bandwidth power. Three types of filters (Rect, Nyquist, Root Nyquist) can be selected.

Pre-installed templates for each standard support easy parameter setting.

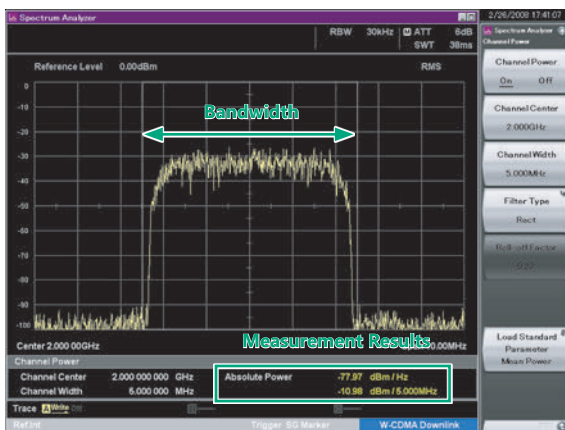

Measurement Results

- Absolute power per Hz in channel band
- Total power in channel band

Occupied Bandwidth

SPA VSA

Occupied bandwidth is measured by selecting either the N% or X-dB mode.

Pre-installed templates for each standard support easy parameter setting.

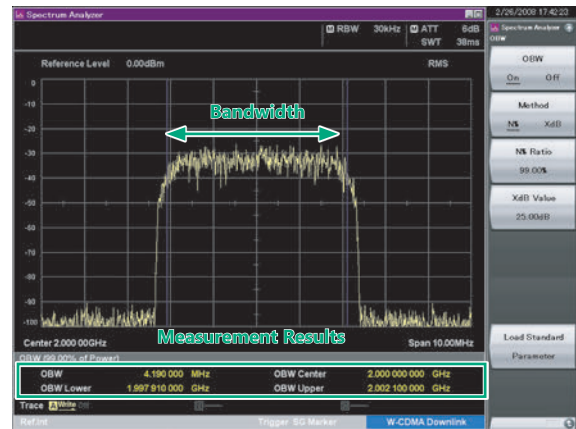

Measurement Results

- Bandwidth for specified conditions

Adjacent Channel Leakage Power

SPA VSA

This function measures carrier adjacent channel (offset) power (In-Band). 1 to 12 carriers can be set and switched instantaneously on-screen.

True ACLR performance is measured using the noise cancellation function to subtract main-frame noise from the measurement result.

Pre-installed templates for each standard support easy parameter setting.



Measurement Results

- Absolute power of Offset channel
- Relative values in relation to reference power selected in ACP reference

Versatile Built-in Functions

Spectrum Emission Mask

SPA

This function splits the offset part into up to 12 segments; the measurement parameters and limit lines can be specified to measure the peak power and margin for each segment. The results are tabulated below the trace and marked PASS/FAIL. Pre-installed templates for each standard support easy parameter setting.

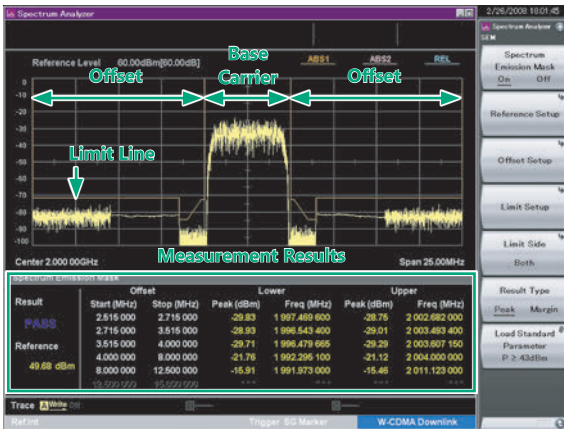

Measurement Results

- Peak power (or margin) at offset
- Each peak frequency

Burst Average Power

SPA

VSA

The average power for the range specified by two markers is displayed in the time domain. Measurement only requires setting the measurement start and stop positions on the screen. True performance is measured using the noise cancellation function to subtract main-frame noise from the measurement result. Pre-installed templates for each standard support easy parameter setting.

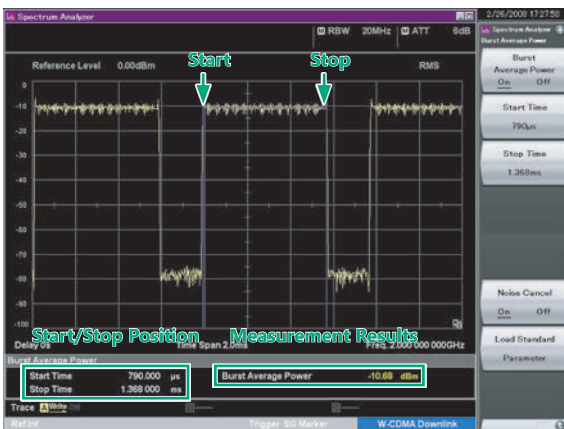

Measurement Results

- Average power of specified range

Spurious Emission

SPA

This function splits the frequency range into up to 20 segments for sweeping; the measurement parameters and limit lines can be specified to measure the peak power and margin for each segment. The results are tabulated below the trace and marked PASS/FAIL. And, zero-span capturing of peak power in time domain is also supported.

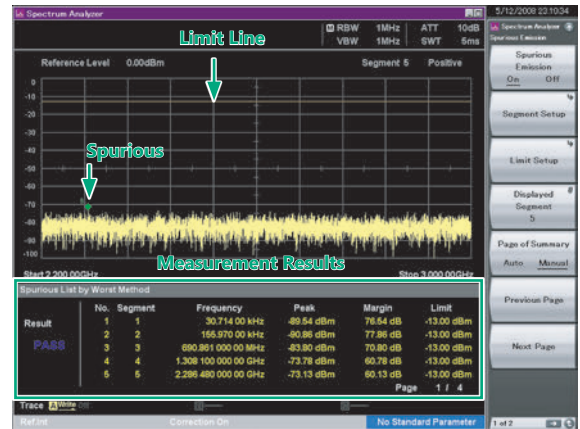

Measurement Results

- Each segment peak power and margin
- Each peak frequency

Example: Spurious Emission

The Japanese Radio Law governing measurement of spurious specifies searching for the peak level in the swept frequency segment using different parameter settings and then performing zero-span measurement of the found peak point. The MS269xA spurious measurement function not only performs the sweep search but also performs the zero-span measurement automatically as well, and displays the results of both. Using zero-span measurement, the search screen is displayed as is while zero-span measurement runs in the background and the result markers are plotted on the search screen. Time wasted by screen switching is reduced and the correlation with the search results can be seen at a glance.

Measurement Example

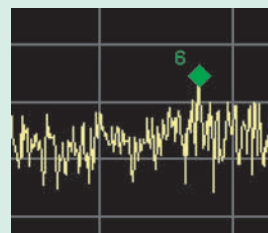

Search only



Search + Measurement

Versatile Built-in Functions

AM Depth

VSA

The Power vs. Time trace measurement function is used to confirm AM depth.

It measures the measured signal AM based on trace data at the displayed marker. When marker is Off, the whole range is measured.

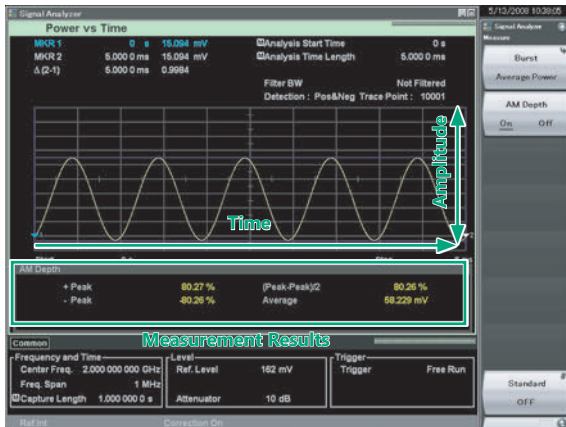

Measurement Results

- +Peak, -Peak, (Peak-Peak)/2, Average

FM Deviation

VSA

The Frequency vs. Time trace measurement is used to confirm the FM deviation. It measures the maximum and minimum frequencies from trace data in the marker range. When marker is Off, the whole range is measured.

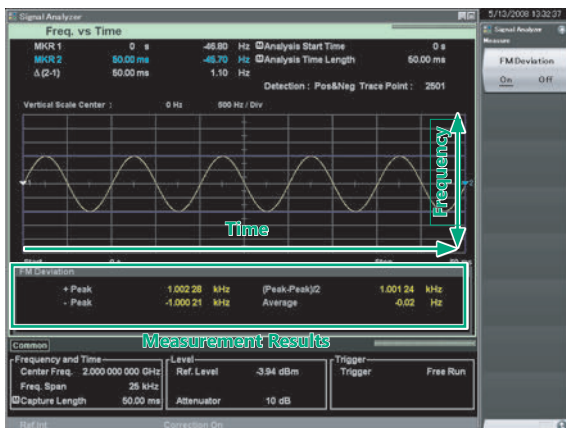

Measurement Results

- +Peak, -Peak, (Peak-Peak)/2, Average

Multi-marker & Marker List

SPA

VSA

Up to 10 markers can be set for this function. Markers may be either a spot or a zone. Using a zone marker, the peak of a signal with an unstable variable frequency can be tracked and measured. Not only can the 10 markers be listed below the trace but the differences between markers can be calculated and displayed using the delta setting.

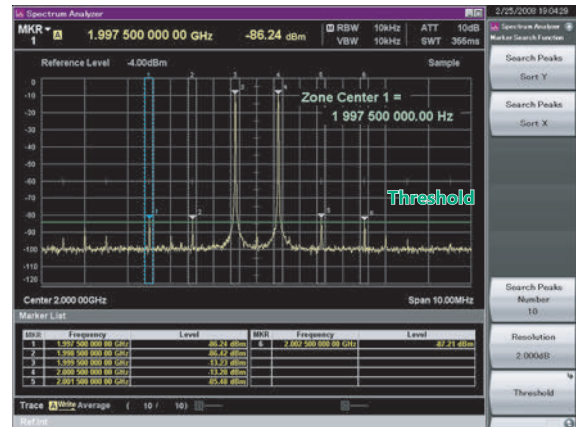

Measurement Results

- Marker point frequency
- Marker point power
- Absolute power per Hz in marker bandwidth
- Total power in marker bandwidth
- Difference between any markers

Highest 10 Markers

SPA

VSA

This function sets the threshold level and auto-detects peaks in the X (frequency) and Y (level/time) directions.

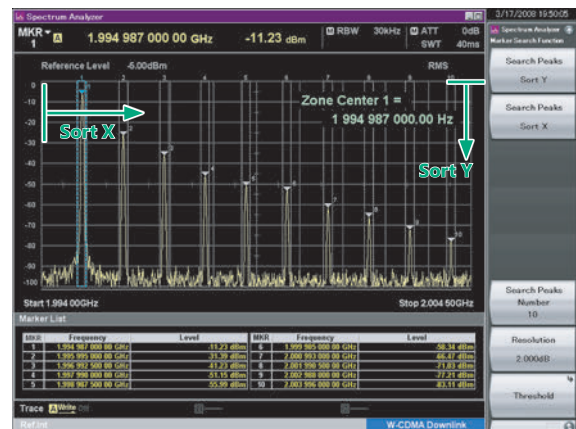

Measurement Results

- Peak Search Y: Sets up to 10 markers in order of peak level
- Peak Search X: Sets up to 10 markers in order of frequency (time) level

Limit Lines

SPA

Setting Limit Lines

Up to six types of Limit line can be set on the spectrum display (frequency domain).

In addition to setting the frequency and level of crossover points manually in sequence from the low frequency, after creating the right half of a line, the left half can be created by reversing and copying the right half, to set a symmetric limit line. Additionally, a Limit line that traces the measured waveform can be created using the Limit Envelope function. A margin can be set on the Limit line in the amplitude direction.

Evaluating using Limit Line Setting (Limit Test Function)

When the waveform is above or below the Limit line, it is evaluated automatically as PASS or FAIL. Evaluation is also possible with an added margin. The target evaluation line can be chosen from any of six types.

Auto-saving Waveform Data using Limit Line Setting (Save on Event Function)

When the waveform matches the evaluation conditions (Event), it can be saved automatically as a csv format file. Any one of the following five Event types can be selected.

- (1) Limit Fail: Saves waveform file when evaluation result is Fail
- (2) Limit Pass: Saves waveform file when evaluation result is Pass
- (3) Margin Fail: Saves waveform file when evaluation result including margin is Fail
- (4) Margin Pass: Saves waveform file when evaluation result including margin is Pass
- (5) Sweep Complete: Saves waveform file at every measurement regardless of evaluation result

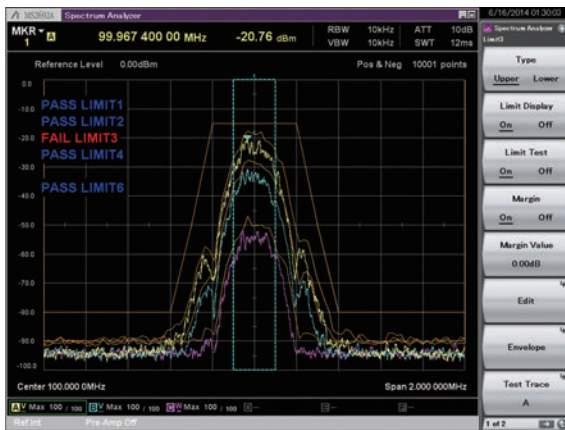

Example:

PASS/FAIL evaluation is performed by changing the input signal level. The evaluation results for the five line types can be displayed simultaneously on one screen.

- Line: Limit 1, Limit 2, Limit 3, Limit 4, Limit 5, Limit 6
- Evaluation Type: Upper Limit, Lower Limit
- Crossover (Point): 1 to 100
- Margin: Set Margin line for each Limit 1, 2, 3, 4, 5, 6
- Evaluation Result: PASS, FAIL
- Result Save: Auto-save as csv format file

Frequency Counter

SPA

This function of the marker functions is used to measure CW frequencies. Gate Time sets the measurement target time.

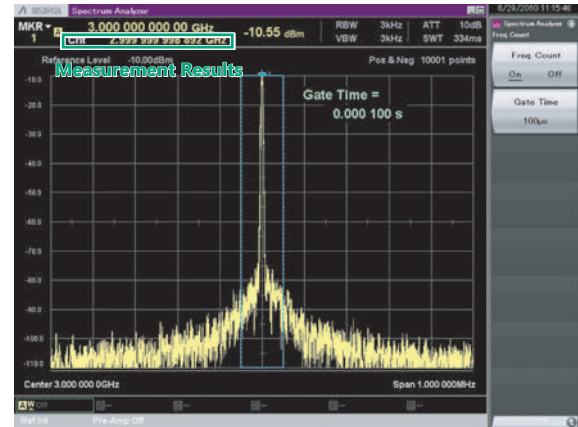

Measurement Results

- Marker point frequency

2-tone 3rd-order Intermodulation Distortion

SPA

By inputting two different frequency CW signals (desired waves), two-tone third-order intermodulation distortion is generated close to the desired waves according to non-linear characteristics of Device Under Test (DUT). Then, Third Order Intercept (TOI) is calculated from the two-tone third-order intermodulation distortion.



Measurement Results

- TOI: [dBm]
- Amplitude: [dBc]

Versatile Built-in Functions

Annotation Display

Screen annotations can be set to On or Off. Annotations about frequency, level, etc., are not displayed at the Off setting.

SPA

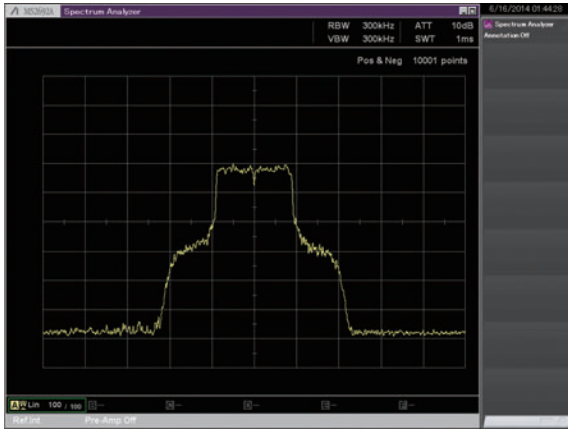

Power Meter

Power meter function can connect a USB power sensor to the MS2830A and read the measurement values.



Phase Noise

This function measures phase noise in the 10 Hz to 10 MHz frequency offset range.

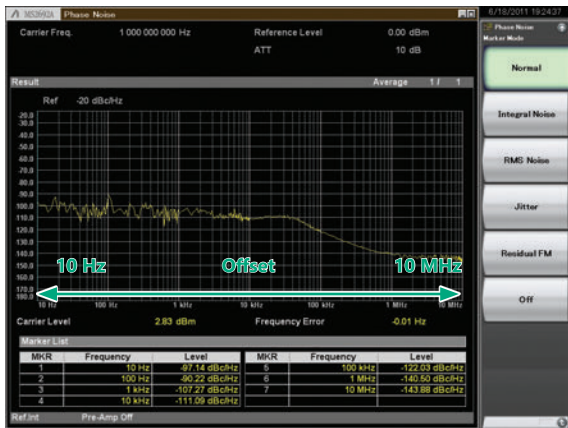

Measurement Results

- Carrier level
- Error between set frequency and carrier frequency
- Marker point phase noise level

Measurement Results

- Power: [dBm], [W]
- Relative power: [dB]

Compatible USB power sensors.

Model	Frequency Range	Dynamic Range
MA24104A*	600 MHz to 4 GHz	+3 to +51.76 dBm
MA24105A	350 MHz to 4 GHz	+3 to +51.76 dBm
MA24106A	50 MHz to 6 GHz	-40 to +23 dBm
MA24108A	10 MHz to 8 GHz	-40 to +20 dBm
MA24118A	10 MHz to 18 GHz	-40 to +20 dBm
MA24126A	10 MHz to 26 GHz	-40 to +20 dBm

*: MA24104A has been discontinued.

Versatile Built-in Functions

Noise Figure Measurement (MS269xA-017)

Noise Figure is measured with the measurement method of Y-factor method which uses a Noise Source.

Frequency Mode: Fixed, List, Sweep

DUT Mode: Amplifier, Down Converter, Up Converter

Screen Layout: Graph, Table

Measurement Results Display

- Graph, List, Spot

Displays measurement results for each trace (Trace1/Trace2).

- Noise Figure (NF) [dB]
- Noise Factor (F) [Linear]
- Gain
- Y-Factor: Power ratio when Noise Source is turned ON/OFF
- T effective: Effective noise temperature
- P Hot: Power measured when Noise Source is On.
- P Cold: Power measured when Noise Source is Off.

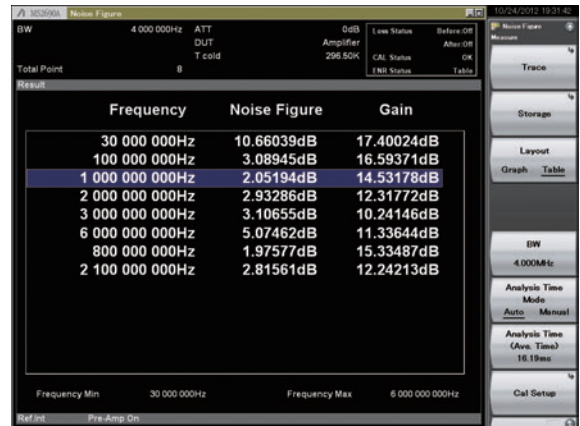

Measurement Result: Example of List display (Frequency Mode: List, Screen Layout: List)

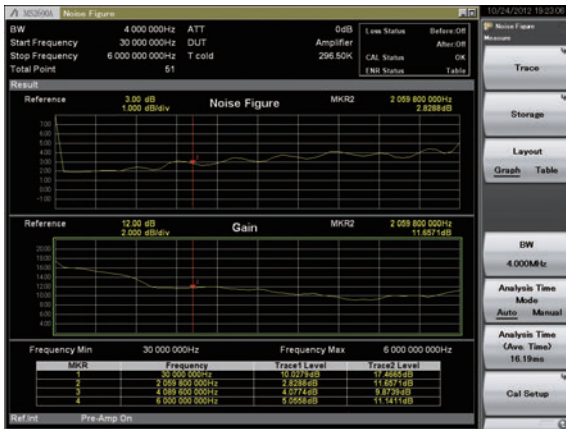

Measurement Result: Example of Graph display (Frequency Mode: Sweep, Screen Layout: Graph)

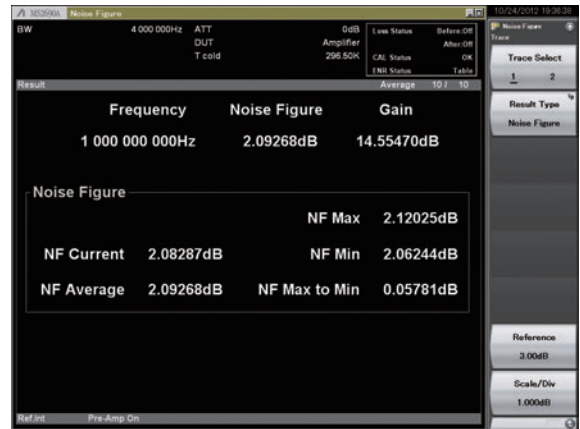

Measurement Result: Example of Spot display (Frequency Mode: Fixed)

Versatile Built-in Functions

Noise Source

Supports noise sources from Noisecom NC346 series. NC346 series models and summary specifications are listed below. See the NC346 series catalog and datasheet for detailed specifications.

NC346 series Summary Specifications

Model	RF Connector	Frequency [GHz]	Output ENR [dB]	VSWR (maximum @ on/off) [GHz]				DC Offset	DC Block
				0.01 to 5	5 to 18	18 to 26.5	26.5 to 40		
NC346A	SMA (M)	0.01 to 18.0	5 to 7	1.15: 1	1.25: 1	—	—	No	Not required
NC346A Precision	APC3.5 (M)	0.01 to 18.0	5 to 7	1.15: 1	1.25: 1	—	—	No	Not required
NC346A Option 1	N (M)	0.01 to 18.0	5 to 7	1.15: 1	1.25: 1	—	—	No	Not required
NC346A Option 2	APC7	0.01 to 18.0	5 to 7	1.15: 1	1.25: 1	—	—	No	Not required
NC346A Option 4	N (F)	0.01 to 18.0	5 to 7	1.15: 1	1.25: 1	—	—	No	Not required
NC346B	SMA (M)	0.01 to 18.0	14 to 16	1.15: 1	1.25: 1	—	—	No	Not required
NC346B Precision	APC3.5 (M)	0.01 to 18.0	14 to 16	1.15: 1	1.25: 1	—	—	No	Not required
NC346B Option 1	N (M)	0.01 to 18.0	14 to 16	1.15: 1	1.35: 1	—	—	No	Not required
NC346B Option 2	APC7	0.01 to 18.0	14 to 16	1.15: 1	1.25: 1	—	—	No	Not required
NC346B Option 4	N (F)	0.01 to 18.0	14 to 16	1.15: 1	1.35: 1	—	—	No	Not required
NC346D	SMA (M)	0.01 to 18.0	19 to 25*1	1.50: 1	1.50: 1	—	—	No	Not required
NC346D Precision	APC3.5 (M)	0.01 to 18.0	19 to 25*1	1.50: 1	1.50: 1	—	—	No	Not required
NC346D Option 1	N (M)	0.01 to 18.0	19 to 25*1	1.50: 1	1.75: 1	—	—	No	Not required
NC346D Option 2	APC7	0.01 to 18.0	19 to 25*1	1.50: 1	1.50: 1	—	—	No	Not required
NC346D Option 3	N (F)	0.01 to 18.0	19 to 25*1	1.50: 1	1.75: 1	—	—	No	Not required
NC346C	APC3.5 (M)	0.01 to 26.5	13 to 17	1.15: 1	1.25: 1	1.35: 1	—	Yes*3	Required*3
NC346E	APC3.5 (M)	0.01 to 26.5	19 to 25*1	1.50: 1	1.50: 1	1.50: 1	—	Yes*3	Required*3
NC346Ka	K (M)*2	0.10 to 40.0	10 to 17	1.25: 1	1.30: 1	1.40: 1	1.50: 1	Yes*3	Required*3

*1: Flatness better than ±2 dB

*2: Compatible with SMA and APC3.5

*3: When using noise sources output by DC, always use in combination with a DC block.

Specifications Outlines of Recommended DC Blocks and Adapters

	Ordering		RF Connector	Frequency Range	VSWR
	Model	Name			
DC Block	J0805	DC Block, N type (MODEL 7003)	N (M)-N (F)	10 kHz to 18 GHz	1.35 (max.)
	J1555A	DC Block, SMA type (MODEL 7006-1)	SMA (M)-SMA (F)	9 kHz to 20 GHz	1.50 (9 kHz to 10 kHz) 1.50 (11 kHz to 20 kHz) 1.30 (20 kHz to 20 GHz)
	K261	DC Block	K (M)-K (F)	10 kHz to 40 GHz	See figure (return loss) below
Adapter	J0004	Coaxial Adapter	N (M)-SMA (F)	DC to 12.4 GHz	≤1.08 (DC to 3 GHz) ≤1.11 (3 GHz to 6 GHz) ≤1.18 (6 GHz to 12.4 GHz)
	J1398A	N-SMA Adapter	N (M)-SMA (F)	DC to 26.5 GHz	≤1.05 (DC to 3 GHz) ≤1.07 (3 GHz to 6 GHz) ≤1.2 (6 GHz to 13.5 GHz) ≤1.3 (13.5 GHz to 20 GHz) ≤1.45 (20 GHz to 26.5 GHz)

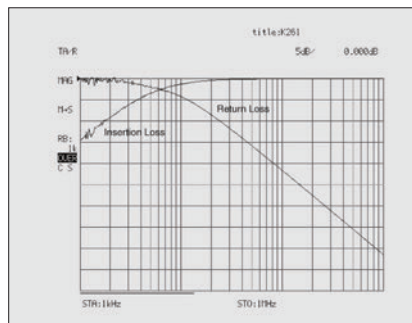

Typical Low Frequency Insertion Loss measured on K261 over the range of 1 kHz to 1 MHz.

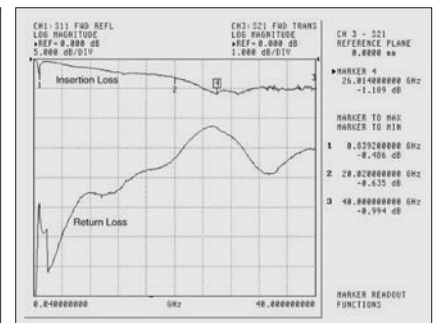

Insertion Loss and Return Loss measured on K261 over the range of 40 MHz to 40 GHz.

K261 DC Block Return Loss

Recommended DC blocks / Adaptor combinations for MS269xA/MS2830A series signal analyzer

	Model	Frequency Range	RF connector	Recommended DC Block Order Name	Recommended Adapter Order Name
MS269xA series	MS2690A	50 Hz to 6 GHz	N (F)	J1555A (from 9 kHz)	J0004
	MS2691A	50 Hz to 13.5 GHz	N (F)	J1555A (from 9 kHz)	J1398A
	MS2692A	50 Hz to 26.5 GHz	N (F)	J1555A (9 kHz to 20 GHz)	J1398A
MS2830A series	MS2830A-040	9 kHz to 3.6 GHz	N (F)	Not required	Not required
	MS2830A-041	9 kHz to 6 GHz	N (F)	Not required	Not required
	MS2830A-043	9 kHz to 13.5 GHz	N (F)	Not required	Not required
	MS2830A-044	9 kHz to 26.5 GHz	N (F)	J1555A (9 kHz to 20 GHz)	J1398A
	MS2830A-045	9 kHz to 43 GHz	K (F)	K261	Not required

Vector Signal Generator (MS269xA-020): Basic Performance

The MS269xA-020 Vector Signal Generator option covers the frequency range from 125 MHz to 6 GHz; it has a wide vector modulation bandwidth of 120 MHz as well as a large built-in memory for storing 256 Msamples. Its level accuracy is at least as good as a dedicated signal generator and the ACLR performance is ideal for Tx tests of devices such as amplifiers and Rx tests of base stations. The all-in-one analyzer and signal generator supports simple configuration of space-saving measurement systems as well as easy signal analysis matching the output timing from the signal generator option.

Frequency Range

Frequency Range: 125 MHz to 6 GHz
Resolution: 0.01 Hz step

The Vector Signal Generator (MS269xA-020) frequency range is 125 MHz to 6 GHz, covering the key wireless communication range.

Internal Baseband Generator

Vector Modulation Bandwidth: 120 MHz
Sampling Clock: 20 kHz to 160 MHz

The wideband 120-MHz vector modulation bandwidth is achieved using the MS269xA-020 baseband signal generator. The sampling clock supports up to 160 MHz.

Example: Vector Modulation Bandwidth

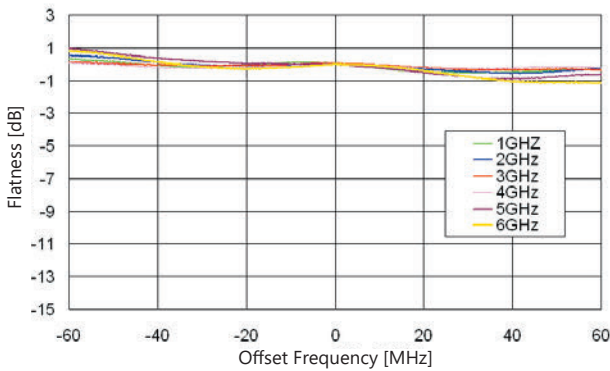

Level Accuracy ± 0.5 dB

Output Level Accuracy (CW):

- ± 0.5 dB (-120 dBm \leq Level \leq $+5$ dBm, Frequency \leq 3 GHz)
- ± 0.8 dB (-110 dBm \leq Level \leq $+5$ dBm, Frequency $>$ 3 GHz)

Example: Frequency Characteristics (Referenced to -5 dBm)

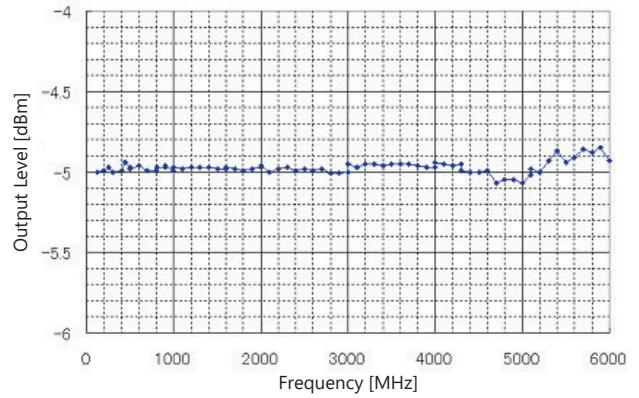

Example: Linearity (Referenced to -5 dBm)

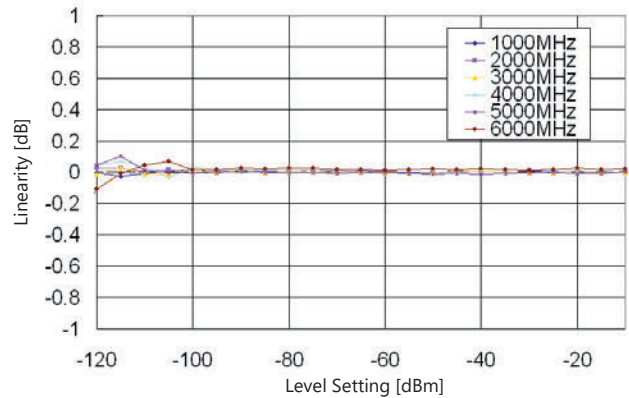

Example: SSB Phase Noise

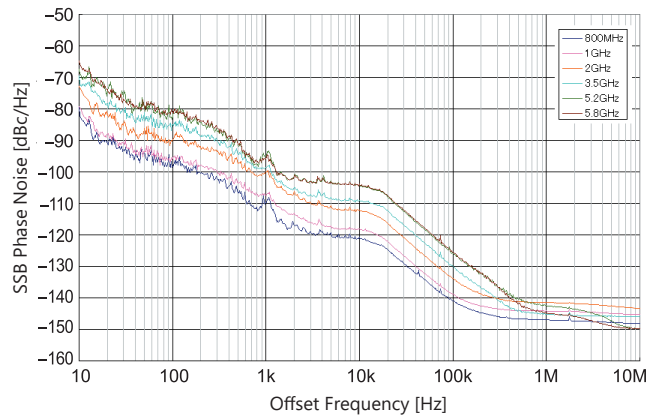

Vector Signal Generator (MS269xA-020): Basic Performance

Large-capacity Memory

1 GB = 256 Msamples/channel

The MS269xA-020 arbitrary waveform memory can save 256 Msamples/channel as well as multiple waveform patterns at the same time. Waveform patterns in memory can be output instantaneously by switching without need to recall from hard disk.

Internal AWGN Generator

Absolute CN Ratio: ≤ 40 dB

This functions adds AWGN (Additive White Gaussian Noise) to the wanted waveform in memory. It is ideal for Tx dynamic range tests.

AWGN band set automatically to sampling clock of wanted signal.

Example: When wanted signal conditions are:

- W-CDMA
- Bandwidth = 3.84 MHz
- Over sampling = $\times 4$

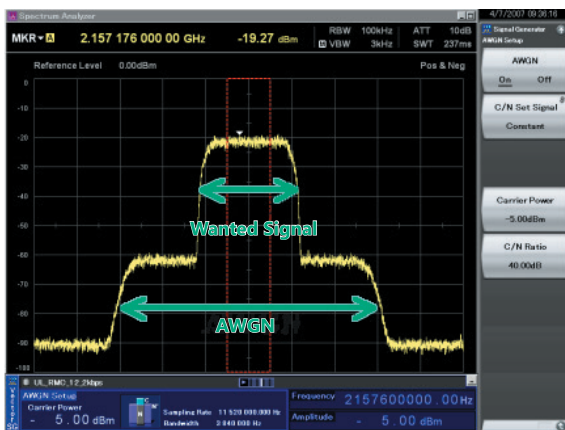

Wanted Signal + AWGN Signal output from one unit

Internal BER Measurement Function

Input Bit Rate: 100 bps to 10 Mbps

Input Level: TTL Level

Input Signal: Data, Clock, Enable

Connector: Rear panel, Aux connector*

*: Requires J1373A AUX Conversion Adapter (sold separately)

Adding the MS269xA-020 Vector Signal Generator option includes a built-in BER tester for measurements up to 10 Mbps. It supports Rx sensitivity tests by inputting the receiver-demodulated Data/Clock/Enable to the back of the MS269xA.

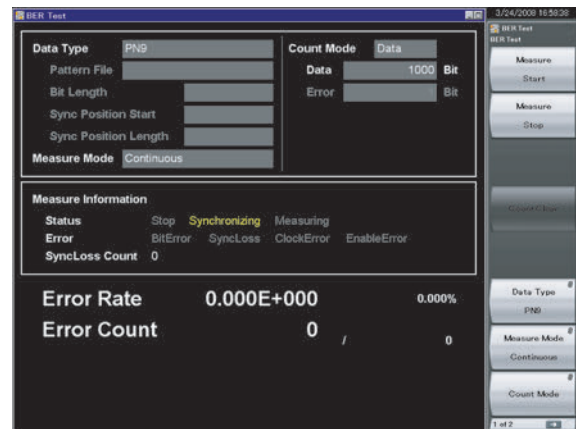

Versatile Multiple Waveform Generation

Any type of waveform can be generated using the MS269xA-020 Signal Generator option. In addition to using C and simulation tools, Anritsu's IQproducer can be run on a PC to edit waveform parameters and output waveforms.

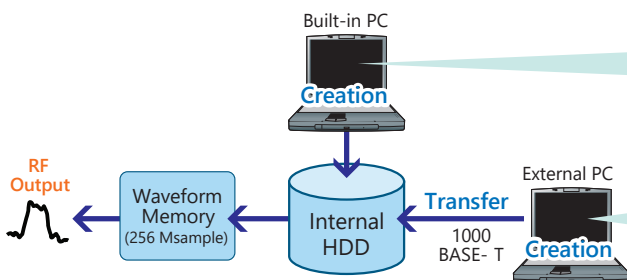

Creating Waveform Using IQproducer

IQproducer is PC software that is used to edit parameters and create any waveform pattern. It can be installed either on an external PC or in the MS269xA main frame.

- HSDPA/HSUPA IQproducer
- TDMA IQproducer
- Multi-carrier IQproducer
- LTE IQproducer
- LTE TDD IQproducer
- WLAN IQproducer
- TD-SCDMA IQproducer
- 5G NR TDD sub-6 GHz IQproducer etc.

Creating Any Waveform

IQ Data created using the MS269xA digitize function or by simulation tools or in C can be converted to a waveform pattern using the SG option and output.

Vector Signal Generator (MS269xA-020): Basic Performance

Useful IQproducer Waveform Generation Software

IQproducer is application software for a PC for editing, creating and transferring waveform patterns using the MS269xA-020 arbitrary waveform generation option. It has the following three main functions.

Parameter Editing:

Function for easily editing parameters matching each communication method

Simulation:

Function for checking generated waveform pattern before transfer to CCDF and FFT graphs

Conversion:

Function for converting ASCII format waveform patterns created by simulation software, files captured using digitizing function, and MG3700A waveform patterns, into files that can be used by MS269xA-020

Parameter Setting Screen (HSDPA/HSUPA IQproducer)

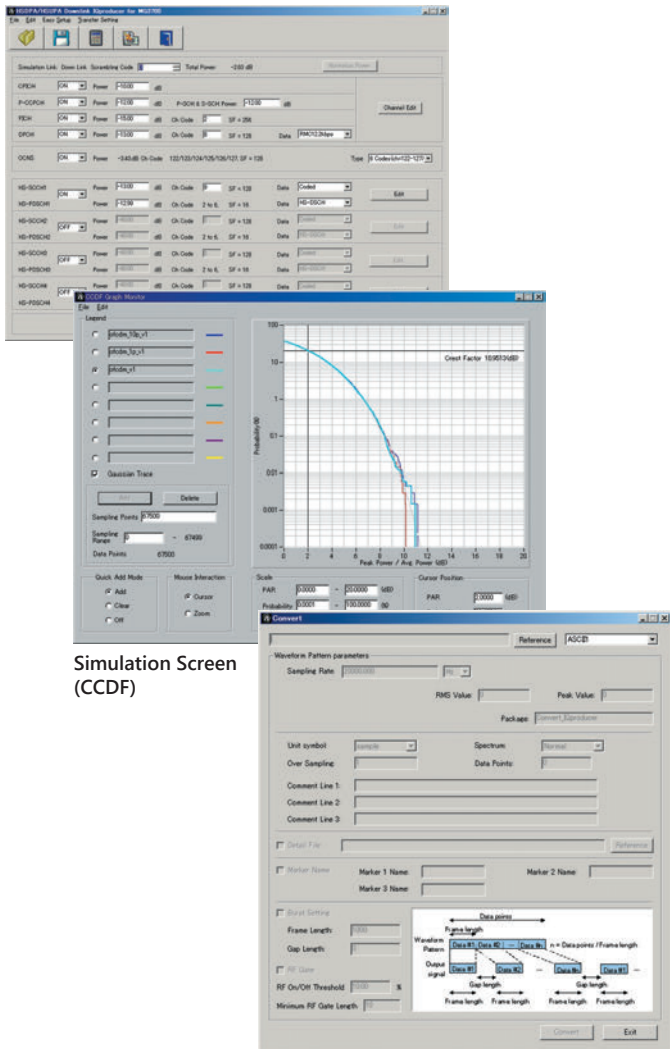

Simulation Screen (CCDF)

Convert Screen

Application

Simplified Tx/Rx Test Setup

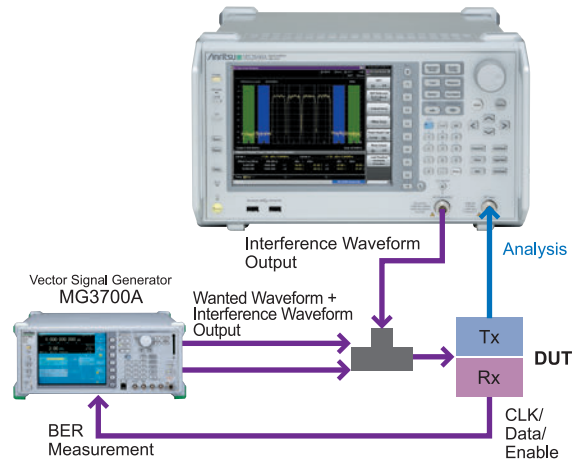

Easy AMP Test

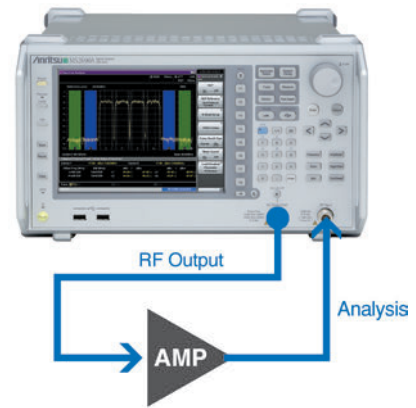

Excellent Expandability Platform (Hardware)

The versatility of the MS269xA series is tailored easily to the application by installing modules in expansion slots.

Basic Function and Performance Upgrades

Rubidium Reference Oscillator MS2690A/MS2691A/MS2692A-001

This option is a 10 MHz reference crystal oscillator with excellent frequency stability startup characteristics of $\pm 1 \times 10^{-9}$ at 7 minutes after power-on.

Aging Rate: $\pm 1 \times 10^{-10}$ /month

Start-up Characteristics: $\pm 1 \times 10^{-9}$ (7 minutes after power-on)

Rubidium Reference Oscillator MS2690A/MS2691A/MS2692A-037

This option is a 10 MHz reference crystal oscillator with excellent frequency stability startup characteristics of $\pm 1 \times 10^{-9}$ at 15 minutes after power-on.

Aging Rate: $\pm 1 \times 10^{-10}$ /month

Start-up Characteristics: $\pm 1 \times 10^{-9}$ (15 minutes after power-on)

Preselector Extended Lower Limit (3 GHz) MS2691A/MS2692A-003

This option extends the lower limit of the preselector from 5.9 GHz to 3 GHz. It can only be installed in the MS2691A/MS2692A.

6 GHz Preamplifier MS2690A/MS2691A/MS2692A-008

This option increases the sensitivity of the spectrum/signal analyzer functions and is used for examining low-level signals such as interference waveforms.

Frequency Range: 100 kHz to 6 GHz

Gain: 14 dB (≤ 3 GHz)

13 dB (3 GHz < Frequency ≤ 4 GHz)

11 dB (4 GHz < Frequency ≤ 5 GHz)

10 dB (5 GHz < Frequency ≤ 6 GHz)

Microwave Preselector Bypass MS2692A-067

Bypassing the preselector used for the microwave band improves RF frequency characteristics and in-band frequency characteristics.

*: Cannot be installed simultaneously with MS2692A-003/008

Signal Analyzer Function and Performance Upgrade

Analysis Bandwidth Extension to 62.5 MHz

MS2690A/MS2691A/MS2692A-077

This option expands the analysis bandwidth to 62.5 MHz.

Analysis Bandwidth Extension to 125 MHz

MS2690A/MS2691A/MS2692A-078*1,*2

This option expands the analysis bandwidth to 125 MHz.

*1: Requires MS269xA-077

*2: Combining with MX269028A-002 wireless LAN IEEE 802.11ac (160 MHz) measurement software (only for MS269xA) supports modulation analysis up to 160-MHz bandwidth signals of the IEEE 802.11ac.

See measurement software catalog for more details

Usage Example: Record Noise and Replay

When the Vector Signal Generator (MS269xA-020) generates a signal based on the data captured by the signal analyzer, a signal that mimics the captured signal can be output*1. The Capture & Playback function can also be used for capture and replay using a simple procedure. For example, a variety of noise sources can be captured and edited using one MS269xA to evaluate the noise tolerance of a product. In some cases, it is not possible to capture minute level fluctuations with a resolution of 20 ns*2, depending on the noise components. In these circumstances, a signal very close to the actual noise can be captured and replayed by setting the resolution to 5 ns*3. (At signal generation, the setting range of the pattern sampling rate must be within the 160 MHz upper limit of the vector signal generator sampling rate.)

*1: Capture time depends on memory capacity.

*2: Sampling rate of 50 MHz at 31.25 MHz FFT band

*3: Sampling rate of 200 MHz at 125 MHz FFT band

Expansion Functions

Noise Figure Measurement Function MS2690A/MS2691A/MS2692A-017

Adds noise figure measurement function.

Noise Figure is measured with the measurement method of Y-factor method which uses a Noise Source.

Vector Signal Generator MS2690A/MS2691A/MS2692A-020

This option is a high-performance waveform generator covering a frequency range of 125 MHz to 6 GHz with a 120 MHz wideband vector modulation band and built-in 256 Msample waveform memory.

Future-proof Platform (Software*)

*: See each software catalog for more details.

Adding measurement software options to the signal analyzer assures that the modulation analysis and other functions will support all common current and future communications systems.

Measurement Software

Communications Systems	Model	Name	Analysis Bandwidth Option (✓: Required, ✓+: Functional expansion, no mark: optional)	
			Option 077	Option 078
W-CDMA/HSPA/ HSPA Evolution	MX269011A	W-CDMA/HSPA Downlink Measurement Software		
	MX269012A	W-CDMA/HSPA Uplink Measurement Software		
W-CDMA/HSPA	MX269030A	W-CDMA BS Measurement Software		
GSM/EDGE	MX269013A	GSM/EDGE Measurement Software		
EDGE Evolution	MX269013A-001	EDGE Evolution Measurement Software		
ETC/DSRC	MX269014A	ETC/DSRC Measurement Software		
TD-SCDMA	MX269015A	TD-SCDMA Measurement Software		
World Digital Wireless Standards	MX269017A	Vector Modulation Analysis Software	✓+	✓+
LTE/LTE-Advanced (FDD)	MX269020A	LTE Downlink Measurement Software		
	MX269020A-001	LTE-Advanced FDD Downlink Measurement Software	✓+	✓+
	MX269021A	LTE Uplink Measurement Software		
	MX269021A-001	LTE-Advanced FDD Uplink Measurement Software	✓+	✓+
LTE/LTE-Advanced (TDD)	MX269022A	LTE TDD Downlink Measurement Software		
	MX269022A-001	LTE-Advanced TDD Downlink Measurement Software	✓+	✓+
	MX269023A	LTE TDD Uplink Measurement Software		
	MX269023A-001	LTE-Advanced TDD Uplink Measurement Software	✓+	✓+
CDMA2000	MX269024A	CDMA2000 Forward Link Measurement Software		
	MX269024A-001	All Measure Function		
1xEV-DO	MX269026A	EV-DO Forward Link Measurement Software		
	MX269026A-001	All Measure Function		
WLAN	MX269028A	WLAN (802.11) Measurement Software (Supports IEEE 802.11n/11a/11b/11g/11j/11p)		
	MX269028A-002*	802.11ac (160 MHz) Measurement Software (for MS269xA)	✓	✓
5G	MX269051A	5G Standard Measurement Software (Base License)		
	MX269051A-011	NR TDD sub-6 GHz Downlink	✓+	✓+
	MX269051A-061	NR TDD sub-6 GHz Uplink	✓+	✓+
	MX269051A-031	NR FDD sub-6 GHz Downlink	✓+	✓+
	MX269051A-081	NR FDD sub-6 GHz Uplink	✓+	✓+

*: Only for MS269xA.

Combining with the MS269xA-078 Analysis Bandwidth Extension to 125 MHz supports modulation analysis up to 160-MHz bandwidth signals of the IEEE 802.11ac.

Adding a license for the IQproducer waveform generation software to the vector signal generator option supports easy generation of test patterns for all common communications systems worldwide.

IQproducer License for MS269xA-020 VSG

Waveforms generated by IQproducer can be downloaded to the MS269xA main frame in which the MS269xA-020 Vector Signal Generator is installed, but the following licenses (option) are required to output the signal.

HSDPA/HSUPA IQproducer	MX269901A
TDMA IQproducer	MX269902A
Multi-Carrier IQproducer	MX269904A
LTE IQproducer	MX269908A
LTE-Advanced FDD Option	MX269908A-001* ⁴
LTE TDD IQproducer	MX269910A
LTE-Advanced TDD Option	MX269910A-001* ⁵
WLAN IQproducer	MX269911A
802.11ac (80 MHz) Option	MX269911A-001* ⁶
TD-SCDMA IQproducer	MX269912A
5G NR TDD sub-6 GHz IQproducer	MX269913A
5G NR FDD sub-6 GHz IQproducer	MX269914A

*⁴: Requires MX269908A.

*⁵: Requires MX269910A.

*⁶: Requires MX269911A.

Waveform Patterns for MS269xA-020 VSG

Various waveforms with preset parameters matching each communication method are provided. The MS269xA-020 Vector Signal Generator option outputs RF signals.

Pre-installed reference waveforms are saved on the MS269xA hard disk for free use.

Pre-installed Patterns

- W-CDMA
- HSDPA (Test Model5)
- CDMA2000 1xEV-DO
- CDMA2000
- GSM/EDGE
- Digital Broadcasting (ISDB-T/CS/BS/CATV)
- WLAN (IEEE 802.11a/b/g)
- Bluetooth

Specifications

Vector Signal Analysis Function/Spectrum Analyzer Function Common

The specification is the value after a 30-minute warm-up at a constant ambient temperature.
Typical values are only for reference and are not guaranteed specifications.

Frequency

Frequency Range	50 Hz to 6.0 GHz (MS2690A) 50 Hz to 13.5 GHz (MS2691A) 50 Hz to 26.5 GHz (MS2692A)		
Frequency Bands	Frequency	Band	Mixer harmonic order (N)
	50 Hz ≤ Frequency ≤ 6.0 GHz	0	1
	3.0 GHz ≤ Frequency ≤ 6.0 GHz	1 – L	1
	5.9 GHz ≤ Frequency ≤ 8.0 GHz	1–	1
	7.9 GHz ≤ Frequency ≤ 13.5 GHz	1+	1
	13.4 GHz ≤ Frequency ≤ 20.0 GHz	2–	2
	19.9 GHz ≤ Frequency ≤ 26.5 GHz	2+	2
	(with MS2691A-003/MS2692A-003, MS2691A/MS2692A) (MS2691A/MS2692A) (MS2691A/MS2692A) (MS2692A) (MS2692A)		
Preselector Range	5.9 GHz to 13.5 GHz (Frequency band mode: Normal) (MS2691A) 5.9 GHz to 26.5 GHz (Frequency band mode: Normal) (MS2692A) 3.0 GHz to 13.5 GHz (Frequency band mode: Spurious) (MS2691A) 3.0 GHz to 26.5 GHz (Frequency band mode: Spurious) (MS2692A)		
Frequency Setting Range	0 Hz to 6.0 GHz (MS2690A) 0 Hz to 13.5 GHz (MS2691A) 0 Hz to 26.5 GHz (MS2692A) Setting resolution: 1 Hz		
Internal Reference Oscillator	Start-up characteristics (23°C, referenced to frequency at 24 h after power-on): ±5 × 10 ⁻⁷ (2 minutes after power-on), ±5 × 10 ⁻⁸ (5 minutes after power-on) Aging rate: ±1 × 10 ⁻⁷ /year, ±1 × 10 ⁻⁸ /day Temperature characteristics: ±2 × 10 ⁻⁸ (5°C to 45°C) with MS269xA-001/037 Rubidium Reference Oscillator		
	Start-up characteristics (23°C, referenced to frequency at 24 h after power-on): ±1 × 10 ⁻⁹ (MS269xA-001: 7 minutes after power-on, MS269xA-037: 15 minutes after power-on) Aging rate: ±1 × 10 ⁻¹⁰ /month Temperature characteristics: ±1 × 10 ⁻⁹ (5°C to 45°C) Note: Unlike the MS269xA-001, the MS269xA-037 start-up characteristics are specified at 15 minutes after power-on. Other specifications are the same for both options.		
SSB Phase Noise	18°C to 28°C, 2 GHz		
	Frequency Offset	Max.	
	100 kHz	-116 dBc/Hz	
	1 MHz	-137 dBc/Hz	

Amplitude

Measurement Range	without MS269xA-008, or Preamp: Off DANL to +30 dBm with MS269xA-008, Preamp: On DANL to +10 dBm
Max. Input Level	without MS269xA-008, or Preamp: Off CW Average power: +30 dBm (Input attenuator: ≥10 dB) DC Voltage: 0 Vdc with MS269xA-008, Preamp: On CW Average power: +10 dBm (Input attenuator: 0 dB) DC Voltage: 0 Vdc
Input Attenuator	0 to 60 dB, 2 dB steps
Input Attenuator Switching Error	Referenced to 10 dB input attenuator without MS269xA-008, or Preamp: Off Frequency band mode: Normal ±0.2 dB (≤6.0 GHz, 10 to 60 dB) ±0.75 dB (>6.0 GHz, 10 to 60 dB) Frequency band mode: Spurious ±0.2 dB (<3.0 GHz, 10 to 60 dB) ±0.75 dB (≥3.0 GHz, 10 to 60 dB) with MS269xA-008, Preamp: On Frequency band mode: Normal ±0.65 dB (≤6.0 GHz, 10 to 60 dB)

Specifications

Vector Signal Analysis Function/Spectrum Analyzer Function Common

Reference Level

Setting Range	Log scale: -120 to +50 dBm, or Equivalent level Linear scale: 22.4 μ V to 70.7 V, or Equivalent level Setting resolution: 0.01 dB, or Equivalent level
Units	Log scale: dBm, dB μ V, dBmV, dB μ V (emf), dB μ V/m, V, W Linear scale: V
Linearity Error	Excluding the noise floor effect without MS269xA-008, or Preamp: Off ± 0.07 dB (Mixer input level: ≤ -20 dBm) ± 0.10 dB (Mixer input level: ≤ -10 dBm) Frequency band mode: Normal, Mixer input level: ≤ 0 dBm ± 0.15 dB (≤ 6.0 GHz) ± 0.50 dB (> 6.0 GHz) (MS2691A) ± 0.60 dB (> 6.0 GHz) (MS2692A) Frequency band mode: Spurious, Mixer input level: ≤ 0 dBm ± 0.15 dB (< 3.0 GHz) ± 0.50 dB (≥ 3.0 GHz) (MS2691A) ± 0.60 dB (≥ 3.0 GHz) (MS2692A) with MS269xA-008, Preamp: On ± 0.07 dB (Preamp input level: ≤ -40 dBm) ± 0.10 dB (Preamp input level: ≤ -30 dBm) Frequency band mode: Normal ± 0.50 dB (Preamp input level: ≤ -20 dBm, ≤ 6.0 GHz)
RF Frequency Characteristics	18°C to 28°C, after CAL, Input attenuator: 10 dB without MS269xA-008, or Preamp: Off ± 0.35 dB (9 kHz \leq Frequency \leq 6.0 GHz, Frequency band mode: Normal) (9 kHz \leq Frequency $<$ 3.0 GHz, Frequency band mode: Spurious) without MS2692A-067, or Microwave Preselector Bypass: Off, after Preselector tuning ± 1.50 dB (6.0 GHz $<$ Frequency \leq 13.5 GHz, Frequency band mode: Normal) (3.0 GHz \leq Frequency \leq 13.5 GHz, Frequency band mode: Spurious) ± 2.50 dB (13.5 GHz $<$ Frequency \leq 26.5 GHz) with MS269xA-008, Preamp: On ± 0.65 dB (100 kHz \leq Frequency \leq 6.0 GHz, Frequency band mode: Normal) (100 kHz \leq Frequency $<$ 3.0 GHz, Frequency band mode: Spurious)
1 dB Gain Compression	without MS269xA-008, or Preamp: Off, Mixer input level $\geq +3$ dBm (100 MHz \leq Frequency $<$ 400 MHz) $\geq +7$ dBm (400 MHz \leq Frequency \leq 6.0 GHz, Frequency band mode: Normal) (400 MHz \leq Frequency $<$ 3.0 GHz, Frequency band mode: Spurious) $\geq +3$ dBm (3.0 GHz \leq Frequency \leq 6.0 GHz, Frequency band mode: Spurious) (MS2691A) (6.0 GHz $<$ Frequency \leq 13.5 GHz) (MS2691A) ≥ 0 dBm (3.0 GHz \leq Frequency \leq 6.0 GHz, Frequency band mode: Spurious) (MS2692A) (6.0 GHz $<$ Frequency \leq 26.5 GHz) (MS2692A) with MS269xA-008, Preamp: On, Preamp input level ≥ -20 dBm (100 MHz \leq Frequency $<$ 400 MHz) ≥ -15 dBm (400 MHz \leq Frequency \leq 6.0 GHz, Frequency band mode: Normal) (400 MHz \leq Frequency $<$ 3.0 GHz, Frequency band mode: Spurious)

Spurious Response

2nd Harmonic Distortion	without MS269xA-008, or Preamp: Off, Mixer input level: -30 dBm						
	<table border="1"> <thead> <tr> <th>Harmonic (dBc)</th> <th>SHI (dBm)</th> </tr> </thead> <tbody> <tr> <td>≤ -60</td> <td>$\geq +30$</td> </tr> <tr> <td>≤ -75</td> <td>$\geq +45$</td> </tr> </tbody> </table> (10 Hz \leq Frequency \leq 400 MHz) (400 MHz $<$ Frequency \leq 3.0 GHz)	Harmonic (dBc)	SHI (dBm)	≤ -60	$\geq +30$	≤ -75	$\geq +45$
	Harmonic (dBc)	SHI (dBm)					
	≤ -60	$\geq +30$					
≤ -75	$\geq +45$						
without MS2692A-067, Mixer input level: -10 dBm							
<table border="1"> <thead> <tr> <th>Harmonic (dBc)</th> <th>SHI (dBm)</th> </tr> </thead> <tbody> <tr> <td>≤ -90</td> <td>$\geq +80$</td> </tr> <tr> <td>≤ -90</td> <td>$\geq +80$</td> </tr> </tbody> </table> (> 3.0 GHz, Frequency band mode: Normal) (≥ 1.5 GHz, Frequency band mode: Spurious)	Harmonic (dBc)	SHI (dBm)	≤ -90	$\geq +80$	≤ -90	$\geq +80$	
Harmonic (dBc)	SHI (dBm)						
≤ -90	$\geq +80$						
≤ -90	$\geq +80$						
Residual Response	with MS2692A-067, Microwave Preselector Bypass: Off, Mixer input level: -10 dBm						
	<table border="1"> <thead> <tr> <th>Harmonic (dBc)</th> <th>SHI (dBm)</th> </tr> </thead> <tbody> <tr> <td>≤ -70</td> <td>$\geq +60$</td> </tr> </tbody> </table> (3 GHz $<$ Frequency \leq 13.25 GHz)	Harmonic (dBc)	SHI (dBm)	≤ -70	$\geq +60$		
	Harmonic (dBc)	SHI (dBm)					
	≤ -70	$\geq +60$					
with MS269xA-008, Preamp: On, Preamp input level: -45 dBm							
<table border="1"> <thead> <tr> <th>Harmonic (dBc)</th> <th>SHI (dBm)</th> </tr> </thead> <tbody> <tr> <td>≤ -50</td> <td>$\geq +5$</td> </tr> <tr> <td>≤ -55</td> <td>$\geq +10$</td> </tr> </tbody> </table> (10 Hz \leq Frequency \leq 400 MHz) (400 MHz $<$ Frequency \leq 3.0 GHz)	Harmonic (dBc)	SHI (dBm)	≤ -50	$\geq +5$	≤ -55	$\geq +10$	
Harmonic (dBc)	SHI (dBm)						
≤ -50	$\geq +5$						
≤ -55	$\geq +10$						
Residual Response	Frequency: ≥ 1 MHz, Input attenuator: 0 dB, 50 Ω terminated Signal Analyzer: with MS269xA-077/078, Except bandwidth setting: > 31.25 MHz ≤ -100 dBm						

Specifications

Vector Signal Analysis Function/Spectrum Analyzer Function Common

Connector

RF Input	Front panel, N-J, 50Ω (nominal) 18°C to 28°C, Input attenuator: ≥ 10 dB VSWR: ≤ 1.2 (nominal, 40 MHz ≤ Frequency ≤ 3.0 GHz) ≤ 1.5 (nominal, 3.0 GHz < Frequency ≤ 6.0 GHz) ≤ 2.0 (nominal, 6.0 GHz < Frequency ≤ 26.5 GHz)
IF Output	Rear panel, BNC-J, 50Ω (nominal) Frequency: 875 MHz (Signal Analyzer, without MS269xA-077/078, or Bandwidth: ≤ 31.25 MHz) 900 MHz (Signal Analyzer, with MS269xA-077/078, Bandwidth: > 31.25 MHz) 874.988 MHz (Spectrum Analyzer) Gain: 0 dB (nominal) (Referenced to RF input level, RF frequency: 1 GHz, Input attenuator: 0 dB) IF Bandwidth: 120 MHz (nominal)
External Reference Input	Rear panel, BNC-J, 50Ω (nominal) Frequency: 10 MHz, 13 MHz Operation range: ± 1 ppm Input level: -15 dBm ≤ Level ≤ +20 dBm, 50Ω (AC coupling)
Reference Signal Output	Rear panel, BNC-J, 50Ω (nominal) Frequency: 10 MHz Output level: ≥ 0 dBm (AC coupling)
Sweep Status Output	Rear panel, BNC-J Output level: TTL Level (High level at sweeping or waveform capture)
Trigger Input	Rear panel, BNC-J Input level: TTL Level
Noise Source Drive	This is available when the MS269xA-017/117 is installed. Supply (+28 V) of the Noise Source Drive. Rear Panel, BNC-J Output Voltage: 28 V ± 0.5 V, Pulsed
External Reference	Control from external controller (Excluding power-on) Ethernet 10/100/1000BASE-T, Rear panel, RJ-45 GPIO: IEEE 488.2, Rear panel, IEEE 488 bus connector Interface functions: SH1, AH1, T6, L4, SR1, RL1, PP0, DC1, DT0, C0, E2 USB (B): USB2.0, Rear panel, USB-B connector
USB	USB2.0 Supporting waveform hard copy to external device, and saving main frame settings USB-A connector (Front panel: 2 ports, Rear panel: 2 ports)
Monitor Output	Rear panel, VGA compatible, mini D-Sub 15 pin
Aux	When using MS269xA-020 trigger input/output Rear panel, 68 pins (DX10BM-68S equivalent)
Display	XGA-color LCD (1024 × 768 resolution), 8.4 inch (213 mm)

General Specifications

Dimensions and Mass	340 (W) × 200 (H) × 350 (D) mm (Excluding projections), ≤ 13.5 kg (Excluding options)	
Power Supply	100 V(ac) to 120 V(ac), 200 V(ac) to 240 V(ac) (-15/+10%, 250 V max.), 50 Hz/60 Hz (±5%) ≤ 260 VA (Excluding options), ≤ 440 VA (Including all options, max.)	
Temperature Range	Operating: +5°C to +45°C, Storage: -20°C to +60°C	
CE	EMC	2014/30/EU, EN61326-1, EN61000-3-2
	LVD	2014/35/EU, EN61010-1
	RoHS	2011/65/EU, EN50581

Specifications

Spectrum Analyzer Function

Frequency

Span	Range: 0 Hz, 300 Hz to 6.0 GHz (MS2690A) 0 Hz, 300 Hz to 13.5 GHz (MS2691A) 0 Hz, 300 Hz to 26.5 GHz (MS2692A) Resolution: 2 Hz Accuracy: $\pm 0.2\%$ (Number of Trace points: 10001)
Display Frequency Accuracy	\pm [Display frequency \times Reference oscillator accuracy + Span frequency \times Span accuracy + RBW \times 0.05 + 2 \times N + Span frequency/(Number of trace points - 1)] Hz N: Mixer harmonic order
Resolution Bandwidth (RBW)	Setting range: 30 Hz to 3 MHz (1-3 sequence), 50 kHz, 5, 10, 20, 31.25 MHz *31.25 MHz: Can be set when Span: 0 Hz only Selectivity (-60 dB/-3 dB): 4.5: 1 (Nominal, 30 Hz to 10 MHz)
Video Bandwidth (VBW)	Setting range: 1 Hz to 10 MHz (1-3 sequence), 5 kHz, Off VBW mode: Video Average, Power Average

Amplitude

Displayed Average Noise Level (DANL)	18°C to 28°C, Detector: Sample, VBW: 1 Hz (Video Average), Input attenuator: 0 dB without MS269xA-008, 6.0 GHz \leq Frequency \leq 26.5 GHz: without MS2692A-067																																	
	<table border="1"> <thead> <tr> <th>Frequency</th> <th>Max.</th> <th>Frequency band mode</th> </tr> </thead> <tbody> <tr> <td>100 kHz</td> <td>-135.0 [dBm/Hz]</td> <td></td> </tr> <tr> <td>1 MHz</td> <td>-145.0 [dBm/Hz]</td> <td></td> </tr> <tr> <td>30 MHz \leq Frequency < 2.4 GHz</td> <td>-155.0 [dBm/Hz]</td> <td></td> </tr> <tr> <td>2.4 GHz \leq Frequency < 3.0 GHz</td> <td>-153.0 [dBm/Hz]</td> <td></td> </tr> <tr> <td>3.0 GHz \leq Frequency < 4.0 GHz</td> <td>-153.0 [dBm/Hz]</td> <td>Normal</td> </tr> <tr> <td>4.0 GHz \leq Frequency < 6.0 GHz</td> <td>-152.0 [dBm/Hz]</td> <td>Normal</td> </tr> <tr> <td>6.0 GHz \leq Frequency < 10.0 GHz</td> <td>-151.0 [dBm/Hz]</td> <td>Normal</td> </tr> <tr> <td>10.0 GHz \leq Frequency \leq 13.5 GHz</td> <td>-150.0 [dBm/Hz]</td> <td>Normal</td> </tr> <tr> <td>13.5 GHz < Frequency \leq 20.0 GHz</td> <td>-147.0 [dBm/Hz]</td> <td>Normal</td> </tr> <tr> <td>20.0 GHz < Frequency \leq 26.5 GHz</td> <td>-143.0 [dBm/Hz]</td> <td>Normal</td> </tr> </tbody> </table>	Frequency	Max.	Frequency band mode	100 kHz	-135.0 [dBm/Hz]		1 MHz	-145.0 [dBm/Hz]		30 MHz \leq Frequency < 2.4 GHz	-155.0 [dBm/Hz]		2.4 GHz \leq Frequency < 3.0 GHz	-153.0 [dBm/Hz]		3.0 GHz \leq Frequency < 4.0 GHz	-153.0 [dBm/Hz]	Normal	4.0 GHz \leq Frequency < 6.0 GHz	-152.0 [dBm/Hz]	Normal	6.0 GHz \leq Frequency < 10.0 GHz	-151.0 [dBm/Hz]	Normal	10.0 GHz \leq Frequency \leq 13.5 GHz	-150.0 [dBm/Hz]	Normal	13.5 GHz < Frequency \leq 20.0 GHz	-147.0 [dBm/Hz]	Normal	20.0 GHz < Frequency \leq 26.5 GHz	-143.0 [dBm/Hz]	Normal
	Frequency	Max.	Frequency band mode																															
	100 kHz	-135.0 [dBm/Hz]																																
	1 MHz	-145.0 [dBm/Hz]																																
	30 MHz \leq Frequency < 2.4 GHz	-155.0 [dBm/Hz]																																
	2.4 GHz \leq Frequency < 3.0 GHz	-153.0 [dBm/Hz]																																
	3.0 GHz \leq Frequency < 4.0 GHz	-153.0 [dBm/Hz]	Normal																															
	4.0 GHz \leq Frequency < 6.0 GHz	-152.0 [dBm/Hz]	Normal																															
	6.0 GHz \leq Frequency < 10.0 GHz	-151.0 [dBm/Hz]	Normal																															
10.0 GHz \leq Frequency \leq 13.5 GHz	-150.0 [dBm/Hz]	Normal																																
13.5 GHz < Frequency \leq 20.0 GHz	-147.0 [dBm/Hz]	Normal																																
20.0 GHz < Frequency \leq 26.5 GHz	-143.0 [dBm/Hz]	Normal																																
with MS269xA-008, Preamp: On																																		
<table border="1"> <thead> <tr> <th>Frequency</th> <th>Max.</th> <th>Frequency band mode</th> </tr> </thead> <tbody> <tr> <td>100 kHz</td> <td>-150.0 [dBm/Hz]</td> <td></td> </tr> <tr> <td>1 MHz</td> <td>-159.0 [dBm/Hz]</td> <td></td> </tr> <tr> <td>30 MHz \leq Frequency < 2.4 GHz</td> <td>-166.0 [dBm/Hz]</td> <td></td> </tr> <tr> <td>2.4 GHz \leq Frequency < 3.0 GHz</td> <td>-165.0 [dBm/Hz]</td> <td></td> </tr> <tr> <td>3.0 GHz \leq Frequency < 4.0 GHz</td> <td>-164.0 [dBm/Hz]</td> <td>Normal</td> </tr> <tr> <td>4.0 GHz \leq Frequency < 5.0 GHz</td> <td>-161.0 [dBm/Hz]</td> <td>Normal</td> </tr> <tr> <td>5.0 GHz \leq Frequency \leq 6.0 GHz</td> <td>-159.0 [dBm/Hz]</td> <td>Normal</td> </tr> </tbody> </table>	Frequency	Max.	Frequency band mode	100 kHz	-150.0 [dBm/Hz]		1 MHz	-159.0 [dBm/Hz]		30 MHz \leq Frequency < 2.4 GHz	-166.0 [dBm/Hz]		2.4 GHz \leq Frequency < 3.0 GHz	-165.0 [dBm/Hz]		3.0 GHz \leq Frequency < 4.0 GHz	-164.0 [dBm/Hz]	Normal	4.0 GHz \leq Frequency < 5.0 GHz	-161.0 [dBm/Hz]	Normal	5.0 GHz \leq Frequency \leq 6.0 GHz	-159.0 [dBm/Hz]	Normal										
Frequency	Max.	Frequency band mode																																
100 kHz	-150.0 [dBm/Hz]																																	
1 MHz	-159.0 [dBm/Hz]																																	
30 MHz \leq Frequency < 2.4 GHz	-166.0 [dBm/Hz]																																	
2.4 GHz \leq Frequency < 3.0 GHz	-165.0 [dBm/Hz]																																	
3.0 GHz \leq Frequency < 4.0 GHz	-164.0 [dBm/Hz]	Normal																																
4.0 GHz \leq Frequency < 5.0 GHz	-161.0 [dBm/Hz]	Normal																																
5.0 GHz \leq Frequency \leq 6.0 GHz	-159.0 [dBm/Hz]	Normal																																
with MS269xA-008, Preamp: Off																																		
<table border="1"> <thead> <tr> <th>Frequency</th> <th>Max.</th> <th>Frequency band mode</th> </tr> </thead> <tbody> <tr> <td>100 kHz</td> <td>-135.0 [dBm/Hz]</td> <td></td> </tr> <tr> <td>1 MHz</td> <td>-145.0 [dBm/Hz]</td> <td></td> </tr> <tr> <td>30 MHz \leq Frequency < 2.4 GHz</td> <td>-153.0 [dBm/Hz]</td> <td></td> </tr> <tr> <td>2.4 GHz \leq Frequency < 3.0 GHz</td> <td>-152.0 [dBm/Hz]</td> <td></td> </tr> <tr> <td>3.0 GHz \leq Frequency < 4.0 GHz</td> <td>-151.0 [dBm/Hz]</td> <td>Normal</td> </tr> <tr> <td>4.0 GHz \leq Frequency < 5.0 GHz</td> <td>-150.0 [dBm/Hz]</td> <td>Normal</td> </tr> <tr> <td>5.0 GHz \leq Frequency < 6.0 GHz</td> <td>-149.0 [dBm/Hz]</td> <td>Normal</td> </tr> </tbody> </table>	Frequency	Max.	Frequency band mode	100 kHz	-135.0 [dBm/Hz]		1 MHz	-145.0 [dBm/Hz]		30 MHz \leq Frequency < 2.4 GHz	-153.0 [dBm/Hz]		2.4 GHz \leq Frequency < 3.0 GHz	-152.0 [dBm/Hz]		3.0 GHz \leq Frequency < 4.0 GHz	-151.0 [dBm/Hz]	Normal	4.0 GHz \leq Frequency < 5.0 GHz	-150.0 [dBm/Hz]	Normal	5.0 GHz \leq Frequency < 6.0 GHz	-149.0 [dBm/Hz]	Normal										
Frequency	Max.	Frequency band mode																																
100 kHz	-135.0 [dBm/Hz]																																	
1 MHz	-145.0 [dBm/Hz]																																	
30 MHz \leq Frequency < 2.4 GHz	-153.0 [dBm/Hz]																																	
2.4 GHz \leq Frequency < 3.0 GHz	-152.0 [dBm/Hz]																																	
3.0 GHz \leq Frequency < 4.0 GHz	-151.0 [dBm/Hz]	Normal																																
4.0 GHz \leq Frequency < 5.0 GHz	-150.0 [dBm/Hz]	Normal																																
5.0 GHz \leq Frequency < 6.0 GHz	-149.0 [dBm/Hz]	Normal																																
Total Level Accuracy*	18°C to 28°C, after CAL, Input attenuator: ≥ 10 dB, Auto Sweep Time Select: Normal, RBW: ≤ 1 MHz, Detection: Positive, CW, Excluding the noise floor effect without MS269xA-008, Preamp: Off Mixer input level: ≤ 0 dBm, ± 0.5 dB (50 Hz \leq Frequency \leq 6.0 GHz, Frequency band mode: Normal) (50 Hz \leq Frequency < 3.0 GHz, Frequency band mode: Spurious) after Preselector tuning ± 1.8 dB (6.0 GHz < Frequency \leq 13.5 GHz, Frequency band mode: Normal) (3.0 GHz \leq Frequency \leq 13.5 GHz, Frequency band mode: Spurious) ± 3.0 dB (13.5 GHz < Frequency \leq 26.5 GHz) with MS269xA-008, Preamp: On Preamp input level: ≤ -20 dBm ± 1.0 dB (100 kHz \leq Frequency \leq 6.0 GHz, Frequency band mode: Normal) (100 kHz \leq Frequency < 3.0 GHz, Frequency band mode: Spurious)																																	
*: The Total level accuracy is found from root sum of squares (RSS) of RF characteristics, linearity error, and input attenuator switching error.																																		

Specifications

Spectrum Analyzer Function

Spurious Response

2-tone 3rd-order Intermodulation Distortion	<p>18°C to 28°C, ≥300 kHz separation</p> <p>without MS269xA-008, or Preamp: Off</p> <p>with MS2692A-067, Microwave Preselector Bypass: Off</p> <p>Mixer input level: -15 dBm (per waveform)</p> <p>≤-60 dBc (TOI: +15 dBm) (30 MHz ≤ Frequency < 400 MHz)</p> <p>≤-66 dBc (TOI: +18 dBm) (400 MHz ≤ Frequency < 700 MHz)</p> <p>≤-74 dBc (TOI: +22 dBm) (700 MHz ≤ Frequency < 4.0 GHz, Frequency band mode: Normal)</p> <p>(700 MHz ≤ Frequency < 3.0 GHz, Frequency band mode: Spurious)</p> <p>≤-66 dBc (TOI: +18 dBm) (4.0 GHz ≤ Frequency ≤ 6.0 GHz, Frequency band mode: Normal)</p> <p>≤-45 dBc (TOI: +7.5 dBm) (6.0 GHz < Frequency ≤ 26.5 GHz, Frequency band mode: Normal)</p> <p>(3.0 GHz ≤ Frequency ≤ 26.5 GHz, Frequency band mode: Spurious)</p> <p>with MS269xA-008, Preamp: On</p> <p>Preamp input level: -45 dBm (per waveform)</p> <p>≤-73 dBc (TOI: -8.5 dBm) (30 MHz ≤ Frequency < 400 MHz)</p> <p>≤-78 dBc (TOI: -6 dBm) (400 MHz ≤ Frequency < 700 MHz)</p> <p>≤-81 dBc (TOI: -4.5 dBm) (700 MHz ≤ Frequency < 4.0 GHz, Frequency band mode: Normal)</p> <p>(700 MHz ≤ Frequency < 3.0 GHz, Frequency band mode: Spurious)</p> <p>≤-78 dBc (TOI: -6 dBm) (4.0 GHz ≤ Frequency ≤ 6.0 GHz, Frequency band mode: Normal)</p>
Image Response	<p>without MS2692A-067</p> <p>≤-70 dBc (Frequency ≤ 13.5 GHz)</p> <p>≤-65 dBc (13.5 GHz < Frequency ≤ 26.5 GHz)</p>

Sweep

Sweep Mode	Single, Continuous
Sweep Time	Setting range: 2 ms to 1000 s (Span: ≥300 Hz), 1 μs to 1000 s (Span: 0 Hz)

Waveform Display

Detector	Pos&Neg, Positive Peak, Sample, Negative Peak, RMS
Number of Trace Points	<p>1001 to 30001 (Span: >500 MHz)</p> <p>101 to 30001 (100 MHz < Span ≤ 500 MHz)</p> <p>(300 Hz ≤ Span ≤ 100 MHz, Sweep time: >10 s)</p> <p>11 to 30001 (300 Hz ≤ Span ≤ 100 MHz, Sweep time: ≤10 s)</p> <p>(Span: 0 Hz, Sweep time: ≤10 s)</p> <p>101 to 30001 (Span: 0 Hz, Sweep time: >10 s)</p> <p>Setting resolution: 1 Hz</p>
Scale	<p>Log display: 10 div/12 div, 0.1 to 20 dB/div (1-2-5 sequence)</p> <p>Lin display: 10 div, 1 to 10%/div (1-2-5 sequence)</p>
Trigger Function	<p>Trigger mode: Free Run (Trig Off), Video, Wide IF, External (TTL)</p> <p>SG Marker (with MS269xA-020), BBIF (with MS269xA-040)</p>
Gate Function	<p>Gate mode: Off, Wide IF, External</p> <p>SG Marker (with MS269xA-020), BBIF (with MS269xA-040)</p>

Measurement Functions

Adjacent Channel Leakage Power (ACP)	Reference: Span Total, Carrier Total, Both side of Carrier, Carrier Select	
Burst Average Power	Adjacent channel specification: 3 channels × 2 (Normal Mode), 8 channels × 2 (Advanced Mode)	
Channel Power	In time domain, displays average power in specified time	
Occupied Bandwidth (OBW)	Absolute value measurement: dBm, dBm/Hz	
Spectrum Emission Mask	N% of Power, X-dB Down	
Spurious Emission	Pass/Fail evaluation at Peak/Margin measurement	
Frequency Counter	Accuracy	Span: ≤1 MHz, RBW: 1 kHz, S/N: ≥50 dB, Gate time: ≥100 ms, ± (Marker frequency × Frequency reference accuracy + (0.01 × N/Gate Time[s]) Hz)
	Gate Time Range	N: Mixer harmonic order
2-tone 3rd-order Intermodulation Distortion	100 μs to 1 s	
2-tone 3rd-order Intermodulation Distortion	Measures IM3 and TOI from two-tone signal.	

Specifications

Vector Signal Analysis Function

Common

Trace Mode	Spectrum, Power vs. Time, Frequency vs. Time, Phase vs. Time, CCDF, Spectrogram, No Trace
Bandwidth	without MS269xA-077/078 Specified analysis bandwidth from center frequency 1 kHz to 25 MHz (1-2.5-5 sequence), 31.25 MHz with MS269xA-077 Adds the 50 MHz, 62.5 MHz bandwidths to the standard analysis bandwidths. with MS269xA-077/078 Adds the 50, 62.5, 100, and 125 MHz bandwidths to the standard analysis bandwidths.
Sampling Rate	Auto-setting depending on RBW without MS269xA-077/078, or Bandwidth: ≤ 31.25 MHz 2 kHz to 50 MHz (1-2-5 sequence) with MS269xA-077, Bandwidth: > 31.25 MHz 100 MHz with MS269xA-077/078, Bandwidth: > 31.25 MHz 100 MHz, 200 MHz
Capture Time	Set length of capture time without MS269xA-077/078, or Bandwidth: ≤ 31.25 MHz Min. capture time length: 2 μ s to 50 ms (determined depending on analysis bandwidth) Max. capture time length: 2 to 2000 s (determined depending on analysis bandwidth) Setting mode: Auto, Manual with MS269xA-077, Bandwidth: > 31.25 MHz Min. capture time length: 1 μ s (determined depending on analysis bandwidth) Max. capture time length: 500 ms with MS269xA-077/078, Bandwidth: > 31.25 MHz Min. capture time length: 500 ns to 1 μ s (determined depending on analysis bandwidth) Max. capture time length: 500 ms
Trigger	Trigger mode: Free Run (Trig Off), Video, Wide IF Video, External (TTL) SG Marker (with MS269xA-020), BBIF (with MS269xA-040)
ADC Resolution	16 bits

Spectrum Display Function

Function Outline	Displays any time length in captured waveform data and spectrum in frequency range
Analysis Time Range	Analysis start time: Set analysis start time point from waveform data header Analysis time length: Set analysis time length Setting mode: Auto, Manual
Frequency	Set center frequency and Span in frequency range of waveform data
Frequency Setting Range	without MS269xA-077/078, or Bandwidth: ≤ 31.25 MHz 0 Hz to 6.0 GHz (MS2690A), 0 Hz to 13.5 GHz (MS2691A), 0 Hz to 26.5 GHz (MS2692A) with MS269xA-077, or with MS269xA-077/078, without MS2692A-067, Bandwidth: > 31.25 MHz 100 MHz to 6.0 GHz with MS269xA-077, or with MS269xA-077/078, with MS2692A-067, Bandwidth: > 31.25 MHz 100 MHz to 26.5 GHz
Resolution Bandwidth (RBW)	without MS269xA-077/078, or Bandwidth: ≤ 31.25 MHz Setting range: 1 Hz to 1 MHz (1-3 sequence) Selectivity (-60 dB/-3 dB): 4.5: 1 (nominal) with MS269xA-077, Bandwidth: > 31.25 MHz Setting range: 3 kHz to 3 MHz (1-3 sequence) Selectivity (-60 dB/-3 dB): 4.5: 1 (nominal) with MS269xA-077/078, Bandwidth: > 31.25 MHz Setting range: 3 kHz to 10 MHz (1-3 sequence) Selectivity (-60 dB/-3 dB): 4.5: 1 (nominal)

Specifications

Vector Signal Analysis Function

Spectrum Display Function (Continuation)

<p>Total Level Accuracy*</p> <p>*: The Total level accuracy is found from root sum of squares (RSS) of RF characteristics, linearity error, and input attenuator switching error.</p>	<p>18°C to 28°C, after CAL, Input attenuator: ≥ 10 dB, Center frequency, CW, RBW: Auto, Time Detection: Average, Marker Result: Integration or Peak (Accuracy), Excluding the noise floor effect</p> <p>Mixer input level: ≤ 0 dBm without MS269xA-077/078, or Bandwidth: ≤ 31.25 MHz without MS269xA-008, or Preamp: Off ± 0.5 dB ($50 \text{ Hz} \leq \text{Frequency} \leq 6.0 \text{ GHz}$, Frequency band mode: Normal) ($50 \text{ Hz} \leq \text{Frequency} < 3.0 \text{ GHz}$, Frequency band mode: Spurious)</p> <p>after Preselector tuning ± 1.8 dB ($6.0 \text{ GHz} < \text{Frequency} \leq 13.5 \text{ GHz}$, Frequency band mode: Normal) ($3.0 \text{ GHz} \leq \text{Frequency} \leq 13.5 \text{ GHz}$, Frequency band mode: Spurious) ± 3.0 dB ($13.5 \text{ GHz} \leq \text{Frequency} \leq 26.5 \text{ GHz}$)</p> <p>with MS269xA-077, or with MS269xA-077/078, Bandwidth: > 31.25 MHz without MS269xA-008, or Preamp: Off ± 0.5 dB ($100 \text{ MHz} \leq \text{Frequency} \leq 6.0 \text{ GHz}$, Frequency band mode: Normal)</p> <p>with MS269xA-077, or with MS269xA-077/078 with MS2692A-067, Microwave Preselector Bypass: On, Bandwidth: > 31.25 MHz ± 1.8 dB ($6.0 \text{ GHz} \leq \text{Frequency} \leq 13.5 \text{ GHz}$, Frequency band mode: Normal) ± 3.0 dB ($13.5 \text{ GHz} \leq \text{Frequency} \leq 26.5 \text{ GHz}$)</p> <p>Preamp input level: ≤ -20 dBm without MS269xA-077/078, or Bandwidth: ≤ 31.25 MHz with MS269xA-008, Preamp: On ± 1.0 dB ($100 \text{ kHz} \leq \text{Frequency} \leq 6.0 \text{ GHz}$, Frequency band mode: Normal) ($100 \text{ kHz} \leq \text{Frequency} < 3.0 \text{ GHz}$, Frequency band mode: Spurious)</p> <p>with MS269xA-077, or with MS269xA-077/078, Bandwidth: > 31.25 MHz with MS269xA-008, Preamp: On ± 1.0 dB ($100 \text{ MHz} \leq \text{Frequency} \leq 6.0 \text{ GHz}$, Frequency band mode: Normal)</p>																																																																																	
<p>Displayed Average Noise Level (DANL)</p>	<p>18°C to 28°C, Input attenuator: 0 dB without MS269xA-008, $6.0 \text{ GHz} \leq \text{Frequency} \leq 26.5 \text{ GHz}$: without MS2692A-067</p> <table border="1" data-bbox="359 1071 1093 1375"> <thead> <tr> <th>Frequency</th> <th>Max.</th> <th>Frequency band mode</th> </tr> </thead> <tbody> <tr> <td>100 kHz</td> <td>-132.5 [dBm/Hz]</td> <td></td> </tr> <tr> <td>1 MHz</td> <td>-142.5 [dBm/Hz]</td> <td></td> </tr> <tr> <td>$30 \text{ MHz} \leq \text{Frequency} < 2.4 \text{ GHz}$</td> <td>-152.5 [dBm/Hz]</td> <td></td> </tr> <tr> <td>$2.4 \text{ GHz} \leq \text{Frequency} < 3.0 \text{ GHz}$</td> <td>-150.5 [dBm/Hz]</td> <td></td> </tr> <tr> <td>$3.0 \text{ GHz} \leq \text{Frequency} < 4.0 \text{ GHz}$</td> <td>-150.5 [dBm/Hz]</td> <td>Normal</td> </tr> <tr> <td>$4.0 \text{ GHz} \leq \text{Frequency} < 6.0 \text{ GHz}$</td> <td>-149.5 [dBm/Hz]</td> <td>Normal</td> </tr> <tr> <td>$6.0 \text{ GHz} \leq \text{Frequency} < 10.0 \text{ GHz}$</td> <td>-148.5 [dBm/Hz]</td> <td>Normal</td> </tr> <tr> <td>$10.0 \text{ GHz} \leq \text{Frequency} \leq 13.5 \text{ GHz}$</td> <td>-147.5 [dBm/Hz]</td> <td>Normal</td> </tr> <tr> <td>$13.5 \text{ GHz} < \text{Frequency} \leq 20.0 \text{ GHz}$</td> <td>-144.5 [dBm/Hz]</td> <td>Normal</td> </tr> <tr> <td>$20.0 \text{ GHz} < \text{Frequency} \leq 26.5 \text{ GHz}$</td> <td>-140.5 [dBm/Hz]</td> <td>Normal</td> </tr> </tbody> </table> <p>with MS269xA-008, Preamp: On</p> <table border="1" data-bbox="359 1407 1093 1627"> <thead> <tr> <th>Frequency</th> <th>Max.</th> <th>Frequency band mode</th> </tr> </thead> <tbody> <tr> <td>100 kHz</td> <td>-147.5 [dBm/Hz]</td> <td></td> </tr> <tr> <td>1 MHz</td> <td>-156.5 [dBm/Hz]</td> <td></td> </tr> <tr> <td>$30 \text{ MHz} \leq \text{Frequency} < 2.4 \text{ GHz}$</td> <td>-163.5 [dBm/Hz]</td> <td></td> </tr> <tr> <td>$2.4 \text{ GHz} \leq \text{Frequency} < 3.0 \text{ GHz}$</td> <td>-162.5 [dBm/Hz]</td> <td></td> </tr> <tr> <td>$3.0 \text{ GHz} \leq \text{Frequency} < 4.0 \text{ GHz}$</td> <td>-161.5 [dBm/Hz]</td> <td>Normal</td> </tr> <tr> <td>$4.0 \text{ GHz} \leq \text{Frequency} < 5.0 \text{ GHz}$</td> <td>-158.5 [dBm/Hz]</td> <td>Normal</td> </tr> <tr> <td>$5.0 \text{ GHz} \leq \text{Frequency} \leq 6.0 \text{ GHz}$</td> <td>-156.5 [dBm/Hz]</td> <td>Normal</td> </tr> </tbody> </table> <p>with MS269xA-008, Preamp: Off</p> <table border="1" data-bbox="359 1659 1093 1879"> <thead> <tr> <th>Frequency</th> <th>Max.</th> <th>Frequency band mode</th> </tr> </thead> <tbody> <tr> <td>100 kHz</td> <td>-132.5 [dBm/Hz]</td> <td></td> </tr> <tr> <td>1 MHz</td> <td>-142.5 [dBm/Hz]</td> <td></td> </tr> <tr> <td>$30 \text{ MHz} \leq \text{Frequency} < 2.4 \text{ GHz}$</td> <td>-150.5 [dBm/Hz]</td> <td></td> </tr> <tr> <td>$2.4 \text{ GHz} \leq \text{Frequency} < 3.0 \text{ GHz}$</td> <td>-149.5 [dBm/Hz]</td> <td></td> </tr> <tr> <td>$3.0 \text{ GHz} \leq \text{Frequency} < 4.0 \text{ GHz}$</td> <td>-148.5 [dBm/Hz]</td> <td>Normal</td> </tr> <tr> <td>$4.0 \text{ GHz} \leq \text{Frequency} < 5.0 \text{ GHz}$</td> <td>-147.5 [dBm/Hz]</td> <td>Normal</td> </tr> <tr> <td>$5.0 \text{ GHz} \leq \text{Frequency} < 6.0 \text{ GHz}$</td> <td>-146.5 [dBm/Hz]</td> <td>Normal</td> </tr> </tbody> </table>	Frequency	Max.	Frequency band mode	100 kHz	-132.5 [dBm/Hz]		1 MHz	-142.5 [dBm/Hz]		$30 \text{ MHz} \leq \text{Frequency} < 2.4 \text{ GHz}$	-152.5 [dBm/Hz]		$2.4 \text{ GHz} \leq \text{Frequency} < 3.0 \text{ GHz}$	-150.5 [dBm/Hz]		$3.0 \text{ GHz} \leq \text{Frequency} < 4.0 \text{ GHz}$	-150.5 [dBm/Hz]	Normal	$4.0 \text{ GHz} \leq \text{Frequency} < 6.0 \text{ GHz}$	-149.5 [dBm/Hz]	Normal	$6.0 \text{ GHz} \leq \text{Frequency} < 10.0 \text{ GHz}$	-148.5 [dBm/Hz]	Normal	$10.0 \text{ GHz} \leq \text{Frequency} \leq 13.5 \text{ GHz}$	-147.5 [dBm/Hz]	Normal	$13.5 \text{ GHz} < \text{Frequency} \leq 20.0 \text{ GHz}$	-144.5 [dBm/Hz]	Normal	$20.0 \text{ GHz} < \text{Frequency} \leq 26.5 \text{ GHz}$	-140.5 [dBm/Hz]	Normal	Frequency	Max.	Frequency band mode	100 kHz	-147.5 [dBm/Hz]		1 MHz	-156.5 [dBm/Hz]		$30 \text{ MHz} \leq \text{Frequency} < 2.4 \text{ GHz}$	-163.5 [dBm/Hz]		$2.4 \text{ GHz} \leq \text{Frequency} < 3.0 \text{ GHz}$	-162.5 [dBm/Hz]		$3.0 \text{ GHz} \leq \text{Frequency} < 4.0 \text{ GHz}$	-161.5 [dBm/Hz]	Normal	$4.0 \text{ GHz} \leq \text{Frequency} < 5.0 \text{ GHz}$	-158.5 [dBm/Hz]	Normal	$5.0 \text{ GHz} \leq \text{Frequency} \leq 6.0 \text{ GHz}$	-156.5 [dBm/Hz]	Normal	Frequency	Max.	Frequency band mode	100 kHz	-132.5 [dBm/Hz]		1 MHz	-142.5 [dBm/Hz]		$30 \text{ MHz} \leq \text{Frequency} < 2.4 \text{ GHz}$	-150.5 [dBm/Hz]		$2.4 \text{ GHz} \leq \text{Frequency} < 3.0 \text{ GHz}$	-149.5 [dBm/Hz]		$3.0 \text{ GHz} \leq \text{Frequency} < 4.0 \text{ GHz}$	-148.5 [dBm/Hz]	Normal	$4.0 \text{ GHz} \leq \text{Frequency} < 5.0 \text{ GHz}$	-147.5 [dBm/Hz]	Normal	$5.0 \text{ GHz} \leq \text{Frequency} < 6.0 \text{ GHz}$	-146.5 [dBm/Hz]	Normal
Frequency	Max.	Frequency band mode																																																																																
100 kHz	-132.5 [dBm/Hz]																																																																																	
1 MHz	-142.5 [dBm/Hz]																																																																																	
$30 \text{ MHz} \leq \text{Frequency} < 2.4 \text{ GHz}$	-152.5 [dBm/Hz]																																																																																	
$2.4 \text{ GHz} \leq \text{Frequency} < 3.0 \text{ GHz}$	-150.5 [dBm/Hz]																																																																																	
$3.0 \text{ GHz} \leq \text{Frequency} < 4.0 \text{ GHz}$	-150.5 [dBm/Hz]	Normal																																																																																
$4.0 \text{ GHz} \leq \text{Frequency} < 6.0 \text{ GHz}$	-149.5 [dBm/Hz]	Normal																																																																																
$6.0 \text{ GHz} \leq \text{Frequency} < 10.0 \text{ GHz}$	-148.5 [dBm/Hz]	Normal																																																																																
$10.0 \text{ GHz} \leq \text{Frequency} \leq 13.5 \text{ GHz}$	-147.5 [dBm/Hz]	Normal																																																																																
$13.5 \text{ GHz} < \text{Frequency} \leq 20.0 \text{ GHz}$	-144.5 [dBm/Hz]	Normal																																																																																
$20.0 \text{ GHz} < \text{Frequency} \leq 26.5 \text{ GHz}$	-140.5 [dBm/Hz]	Normal																																																																																
Frequency	Max.	Frequency band mode																																																																																
100 kHz	-147.5 [dBm/Hz]																																																																																	
1 MHz	-156.5 [dBm/Hz]																																																																																	
$30 \text{ MHz} \leq \text{Frequency} < 2.4 \text{ GHz}$	-163.5 [dBm/Hz]																																																																																	
$2.4 \text{ GHz} \leq \text{Frequency} < 3.0 \text{ GHz}$	-162.5 [dBm/Hz]																																																																																	
$3.0 \text{ GHz} \leq \text{Frequency} < 4.0 \text{ GHz}$	-161.5 [dBm/Hz]	Normal																																																																																
$4.0 \text{ GHz} \leq \text{Frequency} < 5.0 \text{ GHz}$	-158.5 [dBm/Hz]	Normal																																																																																
$5.0 \text{ GHz} \leq \text{Frequency} \leq 6.0 \text{ GHz}$	-156.5 [dBm/Hz]	Normal																																																																																
Frequency	Max.	Frequency band mode																																																																																
100 kHz	-132.5 [dBm/Hz]																																																																																	
1 MHz	-142.5 [dBm/Hz]																																																																																	
$30 \text{ MHz} \leq \text{Frequency} < 2.4 \text{ GHz}$	-150.5 [dBm/Hz]																																																																																	
$2.4 \text{ GHz} \leq \text{Frequency} < 3.0 \text{ GHz}$	-149.5 [dBm/Hz]																																																																																	
$3.0 \text{ GHz} \leq \text{Frequency} < 4.0 \text{ GHz}$	-148.5 [dBm/Hz]	Normal																																																																																
$4.0 \text{ GHz} \leq \text{Frequency} < 5.0 \text{ GHz}$	-147.5 [dBm/Hz]	Normal																																																																																
$5.0 \text{ GHz} \leq \text{Frequency} < 6.0 \text{ GHz}$	-146.5 [dBm/Hz]	Normal																																																																																
<p>Adjacent Channel Leakage Power Measurement (ACP)</p>	<p>Reference: Span Total, Carrier Total, Both Sides of Carriers, Carrier Select Adjacent channel specification: 3 channels \times 2</p>																																																																																	
<p>Channel Power</p>	<p>Absolute value measurement: dBm, dBm/Hz</p>																																																																																	
<p>Occupied Bandwidth (OBW)</p>	<p>N% of Power, \times dB Down</p>																																																																																	

Specifications

Vector Signal Analysis Function

Power vs. Time Display Function

Function Outline	Displays variation in power of captured waveform with time
Analysis Time Range	Analysis start time: Sets analysis start time point from waveform data header Analysis time length: Sets analysis time length Setting mode: Auto, Manual
Resolution Bandwidth	Filter type: Rect, Gaussian, Nyquist, Root Nyquist, Off, (Default: Off) Roll-off ratio: 0.01 to 1 (Set for Nyquist, Root Nyquist) Filter frequency offset: Set center frequency of filter in wavelength data frequency band
AM Depth (Peak to Peak Measurement)	Measures with AM depth or marker function +Peak, -Peak, (P-P)/2, Average
Burst Average Power	Measures average power of burst signal

Frequency vs. Time Display Function

Function Outline	Displays variation in frequency of input signal with time from captured waveform data
Analysis Time Range	Analysis start time: Sets analysis start time point from waveform data header Analysis time length: Sets analysis time length Setting mode: Auto, Manual
Operation Level Range	-17 to +30 dBm (Input attenuator: ≥ 10 dB)
Frequency (Vertical axis)	Sets center frequency and Span in waveform data frequency range Display frequency range: 1/25, 1/10, 1/5, 1/2 of RBW Input frequency range: 10 MHz to 6 GHz
Display Frequency Accuracy	Input level: -17 to +30 dBm (Span: ≤ 31.25 MHz, Scale: Span/25) CW input: \pm (Reference oscillator accuracy \times Center frequency + Display frequency range \times 0.01) Hz
FM Deviation (Peak to Peak Measurement)	Measures with FM deviation or marker function +Peak, -Peak, (P-P)/2, Average

Phase vs. Time Display Function

Function Outline	Displays phase time fluctuation of input signal from captured waveform data
Analysis Time Range	Analysis start time: Sets analysis start time point from waveform data header Analysis time length: Sets analysis time length Setting mode: Auto, Manual
Phase (Vertical axis)	Display mode: Wrap, Unwrap Display phase range: 0.01 deg./div to 200 Gdeg./div Offset: -100 deg. to +100 Mdeg.

CCDF/APD Display Function

Function Outline	Displays CCDF and APD of waveform data captures for fixed time
Analysis Time Range	Analysis start time: Sets analysis start time point from waveform data header Analysis time length: Sets analysis time length Setting mode: Auto, Manual
Display	Displays CCDF or APD as graph Histogram resolution: 0.01 dB Numeric display: Average Power, Max Power, Crest Factor
Resolution Bandwidth (RBW)	Filter type: Rectangle, Off, (Default: Off) Filter frequency offset: Sets filter center frequency in waveform data frequency band

Spectrogram Display Function

Function Outline	Displays spectrogram for time period in captured waveform data
Analysis Time Range	Analysis start time: Sets position of analysis start after waveform data header Analysis time length: Sets analysis time length Setting mode: Auto, Manual
Frequency	Settable as center frequency and span frequency of waveform data
Resolution Bandwidth (RBW)	Setting range: 1 Hz to 1 MHz (1-3 sequence) Selection (-60/-3 dB): 4.5: 1 (nominal)

Digitize Function

Function Outline	Outputs captured waveform data to internal hard disk or external device
Waveform Data	Format: I, Q (32 bit Float Binary format) Level: Sets 0 dBm input to $\sqrt{(I^2 + Q^2)} = 1$ Level accuracy: Same as Total level accuracy of Signal Analyzer
External Output	Output to external PC via Ethernet

Specifications

Vector Signal Analysis Function

Replay Function

Function Outline	Captured waveforms can be replayed again by using the VSA function to read saved digitize data		
Measurable Waveform Data Condition	Format: I, Q (Binary format)		
	Combination of Span, Sampling rate, and Minimum Capture Sample:		
	Span	Sampling Rate	Minimum Capture Sample
	1 kHz	2 kHz	74000 (37 s)
	2.5 kHz	5 kHz	160000 (32 s)
	5 kHz	10 kHz	310000 (31 s)
	10 kHz	20 kHz	610000 (30.5 s)
	25 kHz	50 kHz	730000 (14.6 s)
	50 kHz	100 kHz	730000 (7.3 s)
	100 kHz	200 kHz	730000 (3.65 s)
	250 kHz	500 kHz	730000 (1.46 s)
	500 kHz	1 MHz	730000 (730 ms)
	1 MHz	2 MHz	730000 (365 ms)
	2.5 MHz	5 MHz	730000 (146 ms)
	5 MHz	10 MHz	730000 (73 ms)
	10 MHz	20 MHz	730000 (36.5 ms)
	18.6 MHz	20 MHz	730000 (36.5 ms)
	20 MHz	25 MHz	730000 (29.2 ms)
25 MHz	50 MHz	730000 (14.6 ms)	
31.25 MHz	50 MHz	730000 (14.6 ms)	
50 MHz	100 MHz	730000 (7.3 ms)	
62.5 MHz	100 MHz	730000 (7.3 ms)	
100 MHz	200 MHz	730000 (3.65 ms)	
125 MHz	200 MHz	730000 (3.65 ms)	

Specifications

Hardware Option

Rubidium Reference Oscillator MS2690A/MS2691A/MS2692A-001

Function Outline	Generates 10 MHz reference signal with higher frequency stability
------------------	---

Rubidium Reference Oscillator MS2690A/MS2691A/MS2692A-037

Function Outline	Generates 10 MHz reference signal with higher frequency stability
------------------	---

Extension of Preselector Lower Limit to 3 GHz MS2691A/MS2692A-003

Cannot be installed simultaneously MS2692A-003 and MS2692A-067.

Function Outline	Extends lower limit of preselector to 3 GHz
------------------	---

6 GHz Preamplifier MS2690A/MS2691A/MS2692A-008

Cannot be installed simultaneously MS2692A-008 and MS2692A-067.

Frequency

Range	100 kHz to 6 GHz
-------	------------------

Amplitude

Measurement Range	Displayed average noise level to +10 dBm			
Max. Input Level	CW Average power: +10 dBm (Input attenuator: 0 dB) DC Voltage: 0 Vdc			
Gain	14 dB (Frequency \leq 3.0 GHz), 13 dB (3.0 GHz < Frequency \leq 4.0 GHz), 11 dB (4.0 GHz < Frequency \leq 5.0 GHz), 10 dB (5.0 GHz < Frequency \leq 6.0 GHz)			
Noise Factor	7.0 dB (Frequency \leq 3.0 GHz), 8.5 dB (3.0 GHz < Frequency \leq 4.0 GHz), 9.5 dB (4.0 GHz < Frequency \leq 6.0 GHz)			
Displayed Average Noise Level (DANL)	Spectrum analyzer function: 18°C to 28°C, Input attenuator: 0 dB, Detector: sample, VBW: 1 Hz (Video average) Vector signal analysis function: 18°C to 28°C, Input attenuator: 0 dB Preamp: On			
	Frequency	Max. (Spectrum analyzer function)	Max. (Vector signal analysis function)	
	100 kHz	-150.0 [dBm/Hz]	-147.5 [dBm/Hz]	
	1 MHz	-159.0 [dBm/Hz]	-156.5 [dBm/Hz]	
	30 MHz \leq Frequency < 2.4 GHz	-166.0 [dBm/Hz]	-163.5 [dBm/Hz]	
	2.4 GHz \leq Frequency < 3.0 GHz	-165.0 [dBm/Hz]	-162.5 [dBm/Hz]	
	3.0 GHz \leq Frequency < 4.0 GHz	-164.0 [dBm/Hz]	-161.5 [dBm/Hz]	Normal
	4.0 GHz \leq Frequency < 5.0 GHz	-161.0 [dBm/Hz]	-158.5 [dBm/Hz]	Normal
	5.0 GHz \leq Frequency \leq 6.0 GHz	-159.0 [dBm/Hz]	-156.5 [dBm/Hz]	Normal
	Preamp: Off			
	Frequency	Max. (Spectrum analyzer function)	Max. (Vector signal analysis function)	
	100 kHz	-135.0 [dBm/Hz]	-132.5 [dBm/Hz]	
	1 MHz	-145.0 [dBm/Hz]	-142.5 [dBm/Hz]	
	30 MHz \leq Frequency < 2.4 GHz	-153.0 [dBm/Hz]	-150.5 [dBm/Hz]	
2.4 GHz \leq Frequency < 3.0 GHz	-152.0 [dBm/Hz]	-149.5 [dBm/Hz]		
3.0 GHz \leq Frequency < 4.0 GHz	-151.0 [dBm/Hz]	-148.5 [dBm/Hz]	Normal	
4.0 GHz \leq Frequency < 5.0 GHz	-150.0 [dBm/Hz]	-147.5 [dBm/Hz]	Normal	
5.0 GHz \leq Frequency < 6.0 GHz	-149.0 [dBm/Hz]	-146.5 [dBm/Hz]	Normal	
Input Attenuator Switching Error	Frequency band mode: Normal ± 0.65 dB (≤ 6.0 GHz, 10 to 60 dB)			

Reference Level

RF Frequency Characteristics	18°C to 28°C, After CAL, Input attenuator: 10 dB ± 0.65 dB (100 kHz \leq Frequency \leq 6.0 GHz, Frequency band mode: Normal) (100 kHz \leq Frequency < 3.0 GHz, Frequency band mode: Spurious)
Linearity Error	Excluding the noise floor effect ± 0.07 dB (Preamp input level*: ≤ -40 dBm) ± 0.10 dB (Preamp input level*: ≤ -30 dBm) Frequency band mode: Normal ± 0.5 dB (Preamp input level*: ≤ -20 dBm, frequency: ≤ 6.0 GHz)
1 dB Gain Compression	Preamp input level* ≥ -20 dBm (100 MHz \leq Frequency < 400 MHz) ≥ -15 dBm (400 MHz \leq Frequency \leq 6.0 GHz, Frequency band mode: Normal) (400 MHz \leq Frequency < 3.0 GHz, Frequency band mode: Spurious)

Specifications

Hardware Option

Spurious Response

2nd Harmonic Distortion	Preamp input level*: -45 dBm Harmonic SHI ≤ -50 dBc ≥ +5 dBm (10 Hz ≤ Frequency ≤ 400 MHz) ≤ -55 dBc ≥ +10 dBm (400 MHz < Frequency ≤ 3.0 GHz)
2-tone 3rd-order Intermodulation Distortion	18°C to 28°C, Preamp input level*: -45 dBm (per waveform), ≥ 300 kHz separation ≤ -73 dBc (TOI: -8.5 dBm) (30 MHz ≤ Frequency < 400 MHz) ≤ -78 dBc (TOI: -6 dBm) (400 MHz ≤ Frequency < 700 MHz) ≤ -81 dBc (TOI: -4.5 dBm) (700 MHz ≤ Frequency < 4.0 GHz, Frequency band mode: Normal) (700 MHz ≤ Frequency < 3.0 GHz, Frequency band mode: Spurious) ≤ -78 dBc (TOI: -6 dBm) (4.0 GHz ≤ Frequency ≤ 6.0 GHz, Frequency band mode: Normal)

*: Preamp input level = RF input level – Input attenuator setting value

Noise Figure Measurement Function MS2690A/MS2691A/MS2692A-017*1

Frequency

Frequency range	MS2690A: 30 MHz to 6 GHz MS2691A: 30 MHz to 6 GHz MS2692A: 30 MHz to 6 GHz
Frequency setting range	MS2690A: 10 MHz to 6 GHz MS2691A: 10 MHz to 13.5 GHz MS2692A: 10 MHz to 26.5 GHz

NF Measurement

Within the measurement range,
Attenuator = 0 dB*2

Measurement range	-20 to +40 dB
Instrument Uncertainty	ENR: 4 to 7 dB ±0.02 dB ENR: 12 to 17 dB ±0.025 dB ENR: 20 to 22 dB ±0.03 dB

GAIN Measurement

Measurement range	Within the frequency range -20 to +40 dB
Instrument Uncertainty	Within the measurement range ≤ 0.07

Resolution Bandwidth

Setting Range	100 kHz to 8 MHz
---------------	------------------

Connector

Noise Source	Connector: Rear Panel, BNC-J Output Voltage: 28 V ±0.5 V, Pulsed
--------------	---

*1: Recommending the NC346 Series noise sources by Noisecom company

*2: Recommend to use Pre Amp

Specifications

Hardware Option

Vector Signal Generator MS2690A/MS2691A/MS2692A-020

Frequency

Range	125 MHz to 6 GHz
Resolution	0.01 Hz steps

Output Level

Setting range	-140 to +10 dBm (CW), -140 to 0 dBm (Modulation)
Units	dBm, dBμV (Terminated, Open)
Resolution	0.01 dB
Level Accuracy	18°C to 28°C, CW Output level: p $-120 \leq p \leq +5 \text{ dBm} \quad \pm 0.5 \text{ dB} \quad (\leq 3.0 \text{ GHz})$ $-110 \leq p \leq +5 \text{ dBm} \quad \pm 0.8 \text{ dB} \quad (> 3.0 \text{ GHz})$ $-127 \leq p < -120 \text{ dBm} \quad \pm 0.7 \text{ dB} \quad (\leq 3.0 \text{ GHz})$ $-127 \leq p \leq -110 \text{ dBm} \quad \pm 2.5 \text{ dB (typ.)} \quad (> 3.0 \text{ GHz})$ $-136 \leq p < -127 \text{ dBm} \quad \pm 1.5 \text{ dB (typ.)} \quad (\leq 3.0 \text{ GHz})$
Linearity	18°C to 28°C, CW, Referenced to -5 dBm output Output level: p $-120 \leq p \leq -5 \text{ dBm} \quad \pm 0.2 \text{ dB (typ.)} \quad (\leq 3.0 \text{ GHz})$ $-110 \leq p \leq -5 \text{ dBm} \quad \pm 0.3 \text{ dB (typ.)} \quad (> 3.0 \text{ GHz})$
Connector	N-J connector, 50Ω [Front panel, SG Output (MS269xA-020)]
VSWR	CW: $\leq -5 \text{ dBm}$, Modulation: $\leq -15 \text{ dBm}$ 1.3 ($\leq 3.0 \text{ GHz}$) 1.9 ($> 3.0 \text{ GHz}$)
Max. Reverse Input	1 W peak ($\geq 300 \text{ MHz}$), 0.25 W peak ($< 300 \text{ MHz}$)

Signal Purity

Harmonic Spurious	Output level: $\leq +5 \text{ dBm}$, CW, Output frequency: $\geq 300 \text{ MHz}$ $\leq -30 \text{ dBc}$
Non-harmonic Spurious	Output level: $\leq +5 \text{ dBm}$, CW, Offset: $\geq 15 \text{ kHz}$ (from Output frequency) $< -68 \text{ dBc}$ ($125 \text{ MHz} \leq \text{Frequency} \leq 500 \text{ MHz}$) $< -62 \text{ dBc}$ ($500 \text{ MHz} < \text{Frequency} \leq 1.0 \text{ GHz}$) $< -56 \text{ dBc}$ ($1.0 \text{ GHz} < \text{Frequency} \leq 2.0 \text{ GHz}$) $< -50 \text{ dBc}$ ($2.0 \text{ GHz} < \text{Frequency} \leq 6.0 \text{ GHz}$)

Vector Modulation

18°C to 28°C, SG Level Auto CAL: On

Vector Accuracy	W-CDMA (DL1code) Output level: $\leq -5 \text{ dBm}$, Output frequency: 800 MHz to 2700 MHz $\leq 2\%$ (rms)
Carrier Leak	Output frequency: $\geq 300 \text{ MHz}$ $\leq -40 \text{ dBc}$
Image Rejection	Output frequency: $\geq 300 \text{ MHz}$, Using 10 MHz max. sine wave $\leq -40 \text{ dBc}$
ACLR	Output level: $\leq -5 \text{ dBm}$, Using W-CDMA (Test Model 1 64DPCH) signal, $300 \text{ MHz} \leq \text{Output frequency} \leq 2.4 \text{ GHz}$ $\leq -64 \text{ dBc}/3.84 \text{ MHz}$ (5 MHz offset), $\leq -67 \text{ dBc}/3.84 \text{ MHz}$ (10 MHz offset)
CW and Level Error at Vector Modulation	AWGN signal with bandwidth of 5 MHz, Output frequency: $\geq 300 \text{ MHz}$ $\pm 0.2 \text{ dB}$ (Output level: $\leq -15 \text{ dBm}$) $\pm 0.4 \text{ dB}$ (typ., $-15 \text{ dBm} < \text{Output level:} \leq -5 \text{ dBm}$)
Spectrum Inversion	Supported

Pulse Modulation

On/Off ratio	$\geq 60 \text{ dB}$
Rising/Falling Edge Time	$\leq 90 \text{ ns}$ (10 to 90%)
Pulse Repetition Frequency	DC to 1 MHz (Duty 50%)
External Panel Modulation Signal Input	AUX connector (Rear panel), 600Ω, 0 to 5 V, Threshold value: approx. 1 V

Specifications

Hardware Option

Arbitrary Waveform Generator

Waveform Resolution	14 bits
Marker Output	Three signals (three signals in waveform pattern, or real-time three signals generation), TTL, polarity inversion function
Internal Baseband Reference Clock	Range: 20 kHz to 160 MHz Resolution: 0.001 Hz
External Baseband Reference Clock	Range: 20 kHz to 40 MHz Division, Multiplier function: 1, 2, 4, 8, 16, 1/2, 1/4, 1/8, 1/16 of input signal Input connector: AUX connector (Rear panel), 0.7 Vp-p min. (AC/50Ω), or TTL
Waveform Memory	Memory: 256 Msamples
AWGN Addition Function	CN Ratio absolute value: ≤40 dB

BER Measurement

Connector	AUX connector (Rear panel)
Input Level	TTL Level
Input Signal	Data, Clock, Enable
Input Bit Rate	100 bps to 10 Mbps
Measured Patterns	PN9, PN11, PN15, PN20, PN23, ALL0, ALL1, 01 Repeat PN9Fix, PN11Fix, PN15Fix, PN20Fix, PN23Fix, User Define
Synchronization Establishing Condition	PN Signal: PN stage × 2 bit error free At PNFix Signal: 0 PN stage × 2 bit error free, PN signal and sync establishment, establish sync with PNFix signal at PN stage error free from PNFix signal header bit ALL0, ALL1, 01 Repeat: 10 bit error free User Define: 8 to 1024 bits (variable) error free, Select header bit used at sync detection
Re-synchronization Judgment Condition	x/y y = Measured bit count: Select from 500, 5000, 50000 x = y bit error bit count: Setting range 1 to y/2
Measured Bit Count	≤2 ³² - 1 bits
Measured Error Bit Count	≤2 ³¹ - 1 bits
Measurement End Conditions	Measured bit count, Measured error bit count
Auto Re-synchronization Function	On/Off
Operation at Resync.	Select from Count Clear, and Count Keep
Measurement Mode	Single, Endless, Continuous
Display	Status, Error, Error Rate, Error Count, Sync Loss Count, Measured bit count
Polarity Inversion Function	Data, Clock, Enable polarity inversion
Clear Measurement Function	Clear measured value saved at sync during BER measurement, and select measurement from 0

Specifications

Hardware Option

Microwave Preselector Bypass MS2692A-067

Bypasses the preselector to improve the RF frequency characteristics and the in-band frequency characteristics.

When the preselector option is set to On, the image response elimination filter is bypassed.

Therefore, this function is not appropriate for spurious measurement to receive the image response.

Microwave Preselector Bypass: On (with MS2692A-067), Microwave Preselector Bypass: Off (with special directions)

Cannot install simultaneously with MS2692A-003, MS2692A-008.

Frequency

Frequency Range	6.0 GHz to 26.5 GHz
-----------------	---------------------

Amplitude

RF Frequency Characteristics	18°C to 28°C, after CAL, Input attenuator: 10 dB, Microwave Preselector Bypass: On ± 1.0 dB (6.0 GHz \leq Frequency \leq 13.5 GHz) ± 1.5 dB (13.5 GHz < Frequency \leq 26.5 GHz) * with MS2692A-067, Microwave Preselector Bypass: Off, see Signal Analyzer/Spectrum Analyzer (RF Frequency Characteristics)
Displayed Average Noise Level (DANL)	18°C to 28°C, Detector: Sample, VBW: 1 Hz (Video average), Input attenuator: 0 dB Microwave Preselector Bypass: On or Off -146 dBm/Hz (6.0 GHz \leq Frequency < 10.0 GHz) -145 dBm/Hz (10.0 GHz \leq Frequency \leq 13.5 GHz) -142 dBm/Hz (13.5 GHz < Frequency \leq 20.0 GHz) -138 dBm/Hz (20.0 GHz < Frequency \leq 26.5 GHz)
Image Responses	Microwave Preselector Bypass: Off ≤ -60 dBc (6.0 GHz \leq Frequency \leq 26.5 GHz)

Analysis Bandwidth Extension to 62.5 MHz MS2690A/MS2691A/MS2692A-077

Analysis Bandwidth Extension to 125 MHz MS2690A/MS2691A/MS2692A-078 (Requires MS269xA-077)

Common

Bandwidth	with MS269xA-077 Adds the 50 MHz, 62.5 MHz bandwidths to the standard analysis bandwidths. with MS269xA-077/078 Adds the 50, 62.5, 100, and 125 MHz bandwidths to the standard analysis bandwidths.
Sampling Rate	Auto-setting depending on RBW with MS269xA-077, Bandwidth: >31.25 MHz 100 MHz with MS269xA-077/078, Bandwidth: >31.25 MHz 100 MHz, 200 MHz
Capture Time	Set length of capture time with MS269xA-077, Bandwidth: >31.25 MHz Min. capture time length: 1 μ s (determined depending on analysis bandwidth) Max. capture time length: 500 ms with MS269xA-077/078, Bandwidth: >31.25 MHz Min. capture time length: 500 ns to 1 μ s (determined depending on analysis bandwidth) Max. capture time length: 500 ms
Resolution Bandwidth (RBW)	with MS269xA-077, Bandwidth: >31.25 MHz Setting range: 3 kHz to 3 MHz (1-3 sequence) Selectivity (-60 dB/-3 dB): 4.5: 1 (nominal) with MS269xA-077/078, Bandwidth: >31.25 MHz Setting range: 3 kHz to 10 MHz (1-3 sequence) Selectivity (-60 dB/-3 dB): 4.5: 1 (nominal)
ADC Resolution	with MS269xA-077/078, Bandwidth: >31.25 MHz 14 bits
Frequency	without MS2692A-067, Bandwidth: >31.25 MHz 100 MHz to 6.0 GHz with MS2692A-067, Bandwidth: >31.25 MHz 100 MHz to 26.5 GHz

Specifications

Hardware Option

Amplitude

Displayed Average Noise Level (DANL)	18°C to 28°C, Input attenuator: 0 dB without MS269xA-008, or Preamp: Off, Frequency band mode: Normal									
	<table border="1"> <thead> <tr> <th>Frequency</th> <th>Max.</th> </tr> </thead> <tbody> <tr> <td>100 MHz ≤ Frequency < 2.2 GHz</td> <td>-147.0 [dBm/Hz]</td> </tr> <tr> <td>2.2 GHz ≤ Frequency < 4.0 GHz</td> <td>-145.0 [dBm/Hz]</td> </tr> <tr> <td>4.0 GHz ≤ Frequency ≤ 6.0 GHz</td> <td>-143.0 [dBm/Hz]</td> </tr> </tbody> </table>	Frequency	Max.	100 MHz ≤ Frequency < 2.2 GHz	-147.0 [dBm/Hz]	2.2 GHz ≤ Frequency < 4.0 GHz	-145.0 [dBm/Hz]	4.0 GHz ≤ Frequency ≤ 6.0 GHz	-143.0 [dBm/Hz]	
	Frequency	Max.								
	100 MHz ≤ Frequency < 2.2 GHz	-147.0 [dBm/Hz]								
	2.2 GHz ≤ Frequency < 4.0 GHz	-145.0 [dBm/Hz]								
	4.0 GHz ≤ Frequency ≤ 6.0 GHz	-143.0 [dBm/Hz]								
	with MS269xA-008, Preamp: On, Frequency band mode: Normal									
	<table border="1"> <thead> <tr> <th>Frequency</th> <th>Max.</th> </tr> </thead> <tbody> <tr> <td>100 MHz ≤ Frequency < 2.2 GHz</td> <td>-160.0 [dBm/Hz]</td> </tr> <tr> <td>2.2 GHz ≤ Frequency < 4.0 GHz</td> <td>-158.0 [dBm/Hz]</td> </tr> <tr> <td>4.0 GHz ≤ Frequency ≤ 6.0 GHz</td> <td>-154.0 [dBm/Hz]</td> </tr> </tbody> </table>	Frequency	Max.	100 MHz ≤ Frequency < 2.2 GHz	-160.0 [dBm/Hz]	2.2 GHz ≤ Frequency < 4.0 GHz	-158.0 [dBm/Hz]	4.0 GHz ≤ Frequency ≤ 6.0 GHz	-154.0 [dBm/Hz]	
	Frequency	Max.								
	100 MHz ≤ Frequency < 2.2 GHz	-160.0 [dBm/Hz]								
2.2 GHz ≤ Frequency < 4.0 GHz	-158.0 [dBm/Hz]									
4.0 GHz ≤ Frequency ≤ 6.0 GHz	-154.0 [dBm/Hz]									
with MS2692A-067, Microwave Preselector Bypass: On										
<table border="1"> <thead> <tr> <th>Frequency</th> <th>Max.</th> </tr> </thead> <tbody> <tr> <td>6.0 GHz < Frequency < 10.0 GHz</td> <td>-140.0 [dBm/Hz]</td> </tr> <tr> <td>10.0 GHz ≤ Frequency ≤ 13.5 GHz</td> <td>-136.0 [dBm/Hz]</td> </tr> <tr> <td>13.5 GHz < Frequency ≤ 20.0 GHz</td> <td>-133.0 [dBm/Hz]</td> </tr> <tr> <td>20.0 GHz < Frequency ≤ 26.5 GHz</td> <td>-129.0 [dBm/Hz]</td> </tr> </tbody> </table>	Frequency	Max.	6.0 GHz < Frequency < 10.0 GHz	-140.0 [dBm/Hz]	10.0 GHz ≤ Frequency ≤ 13.5 GHz	-136.0 [dBm/Hz]	13.5 GHz < Frequency ≤ 20.0 GHz	-133.0 [dBm/Hz]	20.0 GHz < Frequency ≤ 26.5 GHz	-129.0 [dBm/Hz]
Frequency	Max.									
6.0 GHz < Frequency < 10.0 GHz	-140.0 [dBm/Hz]									
10.0 GHz ≤ Frequency ≤ 13.5 GHz	-136.0 [dBm/Hz]									
13.5 GHz < Frequency ≤ 20.0 GHz	-133.0 [dBm/Hz]									
20.0 GHz < Frequency ≤ 26.5 GHz	-129.0 [dBm/Hz]									
Total Level Accuracy*	18°C to 28°C, after CAL, Input attenuator: ≥10 dB, Center frequency, CW, RBW: Auto, Time Detection: Average, Marker Result: Integration or Peak (Accuracy), Excluding the noise floor effect without MS269xA-008, or Preamp: Off, Mixer input level: ≤0 dBm, Bandwidth: >31.25 MHz ±0.5 dB (100 MHz ≤ Frequency ≤ 6.0 GHz, Frequency band mode: Normal) with MS269xA-008, Preamp: On, Preamp input level: ≤-20 dBm, Bandwidth: >31.25 MHz ±1.0 dB (100 MHz ≤ Frequency ≤ 6.0 GHz, Frequency band mode: Normal) with MS269xA-077, or MS269xA-077/078, Bandwidth: >31.25 MHz with MS2692A-067, Microwave Preselector Bypass: On ±1.8 dB (6.0 GHz ≤ Frequency ≤ 13.5 GHz, Frequency band mode: Normal) ±3.0 dB (13.5 GHz ≤ Frequency ≤ 26.5 GHz)									
*: The Total level accuracy is found from root sum of squares (RSS) of RF characteristics, linearity error, and input attenuator switching error.										
Linearity Error	Excluding the noise floor effect without MS269xA-008, or Preamp: Off, Frequency band mode: Normal ±0.07 dB (Mixer input level: ≤-20 dBm) ±0.10 dB (Mixer input level: ≤-10 dBm) ±0.30 dB (Mixer input level: ≤0 dBm, Frequency: ≤6.0 GHz) with MS269xA-008, Preamp: On, Frequency band mode: Normal ±0.07 dB (Mixer input level: ≤-40 dBm) ±0.10 dB (Mixer input level: ≤-30 dBm) ±0.50 dB (Mixer input level: ≤-20 dBm) with MS2692A-067, Microwave Preselector Bypass: On ±0.60 dB (Mixer input level: ≤0 dBm, Frequency: > 6.0 GHz)									
RF Frequency Characteristics	18°C to 28°C, After CAL, Input attenuator: 10 dB without MS269xA-008, or Preamp: Off ±0.35 dB (100 MHz ≤ Frequency ≤ 6.0 GHz, Frequency band mode: Normal) with MS269xA-008, Preamp: On ±0.65 dB (100 MHz ≤ Frequency ≤ 6.0 GHz, Frequency band mode: Normal) with MS2692A-067, Microwave Preselector Bypass: On ±1.0 dB (6.0 GHz < Frequency ≤ 13.5 GHz) ±1.5 dB (13.5 GHz < Frequency ≤ 26.5 GHz)									

Note: Amplitude errors may occur in digitized IQ data at a probability of 0.0001 ppm or less. (AD converter maker nominal specifications) when the Analysis Bandwidth Extension 62.5 MHz/125 MHz option operates at the 50 MHz/62.5 MHz/100 MHz/125 MHz bandwidth setting.

Typical (typ.): Performance not warranted. Must products meet typical performance.

Nominal (nom.): Values not warranted. Included to facilitate application of product.

Example: Performance not warranted. Data actually measured by randomly selected measuring instruments.

Ordering Information

Please specify the model/order number, name and quantity when ordering.
The names listed in the chart below are Order Names. The actual name of the item may differ from the Order Name.

Model/Order No.	Name
	Main Frame
MS2690A	Signal Analyzer (50 Hz to 6.0 GHz)
MS2691A	Signal Analyzer (50 Hz to 13.5 GHz)
MS2692A	Signal Analyzer (50 Hz to 26.5 GHz)
	Standard Accessories
	Power Cord : 1 pc
P0031A	USB Memory (> 1 GB USB2.0 Flash Driver) : 1 pc
Z0541A	USB Mouse : 1 pc
	Install CD-ROM (Application software, instruction manual CD-ROM) : 1 pc
	Options
MS2690A-001	Rubidium Reference Oscillator
MS2690A-037	Rubidium Reference Oscillator
MS2690A-008	6 GHz Preamplifier (100 kHz to 6 GHz)
MS2690A-017	Noise Figure Measurement Function
MS2690A-020	Vector Signal Generator (125 MHz to 6 GHz)
MS2690A-077	Analysis Bandwidth Extension to 62.5 MHz
MS2690A-078*2	Analysis Bandwidth Extension to 125 MHz (Requires MS2690A-077)
MS2691A-001	Rubidium Reference Oscillator
MS2691A-037	Rubidium Reference Oscillator
MS2691A-003	Extension of Preselector Lower Limit to 3 GHz (Extends lower limit of preselector to 3 GHz)
MS2691A-008	6 GHz Preamplifier (100 kHz to 6 GHz)
MS2691A-017	Noise Figure Measurement Function
MS2691A-020	Vector Signal Generator (125 MHz to 6 GHz)
MS2691A-077	Analysis Bandwidth Extension to 62.5 MHz
MS2691A-078*2	Analysis Bandwidth Extension to 125 MHz (Requires MS2691A-077)
MS2692A-001	Rubidium Reference Oscillator
MS2692A-037	Rubidium Reference Oscillator
MS2692A-003	Extension of Preselector Lower Limit to 3 GHz (Extends lower limit of preselector to 3 GHz)
MS2692A-008	6 GHz Preamplifier (100 kHz to 6 GHz)
MS2692A-017	Noise Figure Measurement Function
MS2692A-020	Vector Signal Generator (125 MHz to 6 GHz)
MS2692A-067*3	Microwave Preselector Bypass
MS2692A-077	Analysis Bandwidth Extension to 62.5 MHz
MS2692A-078*2	Analysis Bandwidth Extension to 125 MHz (Requires MS2692A-077)
	Retrofit Options
MS2690A-101	Rubidium Reference Oscillator Retrofit
MS2690A-137	Rubidium Reference Oscillator Retrofit
MS2690A-108	6 GHz Preamplifier Retrofit (100 kHz to 6 GHz)
MS2690A-117	Noise Figure Measurement Function Retrofit
MS2690A-120	Vector Signal Generator Retrofit (125 MHz to 6 GHz)
MS2690A-177*1	Analysis Bandwidth Extension to 62.5 MHz Retrofit
MS2690A-178*1, *2	Analysis Bandwidth Extension to 125 MHz Retrofit (Requires MS2690A-077/177)
MS2690A-282*4	CPU/Windows10 Upgrade Retrofit
MS2690A-283*4	CPU/WindowsXP to 10 Upgrade Retrofit
MS2691A-101	Rubidium Reference Oscillator Retrofit
MS2691A-137	Rubidium Reference Oscillator Retrofit
MS2691A-103	Extension of Preselector Lower Limit to 3 GHz Retrofit (Extends lower limit of pre-selector to 3 GHz)
MS2691A-108	6 GHz Preamplifier Retrofit (100 kHz to 6 GHz)
MS2691A-117	Noise Figure Measurement Function Retrofit
MS2691A-120	Vector Signal Generator Retrofit (125 MHz to 6 GHz)
MS2691A-177*1	Analysis Bandwidth Extension to 62.5 MHz Retrofit
MS2691A-178*1, *2	Analysis Bandwidth Extension to 125 MHz Retrofit (Requires MS2691A-077/177)
MS2691A-282*4	CPU/Windows10 Upgrade Retrofit
MS2691A-283*4	CPU/WindowsXP to 10 Upgrade Retrofit
MS2692A-101	Rubidium Reference Oscillator Retrofit
MS2692A-137	Rubidium Reference Oscillator Retrofit
MS2692A-103	Extension of Preselector Lower Limit to 3 GHz Retrofit (Extends lower limit of pre-selector to 3 GHz)
MS2692A-108	6 GHz Preamplifier Retrofit (100 kHz to 6 GHz)
MS2692A-117	Noise Figure Measurement Function Retrofit
MS2692A-120	Vector Signal Generator Retrofit (125 MHz to 6 GHz)
MS2692A-167*3	Microwave Preselector Bypass Retrofit
MS2692A-177*1	Analysis Bandwidth Extension to 62.5 MHz Retrofit
MS2692A-178*1, *2	Analysis Bandwidth Extension to 125 MHz Retrofit (Requires MS2692A-077/177)
MS2692A-282*4	CPU/Windows10 Upgrade Retrofit
MS2692A-283*4	CPU/WindowsXP to 10 Upgrade Retrofit

Model/Order No.	Name
	Software Options
	CD-ROM with License and Operation manuals
MX269011A	W-CDMA/HSPA Downlink Measurement Software
MX269012A	W-CDMA/HSPA Uplink Measurement Software
MX269013A	GSM/EDGE Measurement Software
MX269013A-001	EDGE Evolution Measurement Software (Requires MX269013A)
MX269014A	ETC/DSRC Measurement Software
MX269015A	TD-SCDMA Measurement Software
MX269017A	Vector Modulation Analysis Software
MX269020A	LTE Downlink Measurement Software
MX269020A-001	LTE-Advanced FDD Downlink Measurement Software (Requires MX269020A)
MX269021A	LTE Uplink Measurement Software
MX269021A-001	LTE-Advanced FDD Uplink Measurement Software (Requires MX269021A)
MX269022A	LTE TDD Downlink Measurement Software
MX269022A-001	LTE-Advanced TDD Downlink Measurement Software (Requires MX269022A)
MX269023A	LTE TDD Uplink Measurement Software
MX269023A-001	LTE-Advanced TDD Uplink Measurement Software (Requires MX269023A)
MX269024A	CDMA2000 Forward Link Measurement Software
MX269024A-001	All Measure Function (Requires MX269024A)
MX269026A	EV-DO Forward Link Measurement Software
MX269026A-001	All Measure Function (Requires MX269026A)
MX269028A	WLAN (802.11) Measurement Software
MX269028A-002*2	802.11ac (160 MHz) Measurement Software (For MS269xA. Requires MX269028A)
MX269030A	W-CDMA BS Measurement Software
MX269051A	5G Standard Measurement Software (Base License) (Requires MX269051A-011 and/or 031/061/081)
MX269051A-011	NR TDD sub-6 GHz Downlink (Requires MX269051A)
MX269051A-061	NR TDD sub-6 GHz Uplink (Requires MX269051A)
MX269051A-031	NR FDD sub-6 GHz Downlink (Requires MX269051A)
MX269051A-081	NR FDD sub-6 GHz Uplink (Requires MX269051A)

- *1: The MS269xA-177/178 cannot be retrofitted to the MS269xA already fitted with the MS269xA-004/104 option (discontinued).
- *2: Combining the MS269xA-078 Analysis Bandwidth Extension to 125 MHz and MX269028A-002 wireless LAN IEEE 802.11ac (160 MHz) measurement software (only for MS269xA) supports modulation analysis up to 160-MHz bandwidth signals of the IEEE 802.11ac.
See measurement software catalog for more details.
- *3: Cannot be installed simultaneously with MS2692A-003/103/008/108 and MS2692A-004/104 option (discontinued).
- *4: These options replaces the MS269xA CPU with Windows XP or Windows 7 and upgrades to Windows 10.
The MS269xA with Windows 7 has a sticker marked "C1" near the serial number of the main unit, and Windows 10 has a sticker marked "C2". No seal is attached to Windows XP.
Installation of Windows 10 is not supported for MS269xA units with the following options installed.

Model number	Model name
MS2690A-004/104*/204*	Wideband Analysis Hardware/Retrofit
MS2691A-004/104*/204*	
MS2692A-004/104*/204*	
MS2690A-050/150*/250*	HDD Digitizing Interface/Retrofit
MS2691A-050/150*/250*	
MS2692A-050/150*/250*	
MS2690A-065/165*/265*	DigRF v4 High Speed Serial Transmission Unit/Retrofit
MS2691A-065/165*/265*	
MS2692A-065/165*/265*	
MS2691A-030/130*/230*	W-CDMA RNC Simulator (ATM1.5M/2M)/Retrofit
MS2691A-040/140*/240*	Baseband Interface Unit/Retrofit
MS2692A-040/140*/240*	

*: Retrofit option

Ordering Information

Model/Order No.	Name	Model/Order No.	Name
MX269901A	HSDPA/HSUPA IQproducer	W3098AE	MX269011A Operation Manual (Operation)
MX269902A	TDMA IQproducer	W3099AE	MX269011A Operation Manual (Remote control)
MX269904A	Multi-Carrier IQproducer	W3060AE	MX269012A Operation Manual (Operation)
MX269908A	LTE IQproducer	W3061AE	MX269012A Operation Manual (Remote control)
MX269908A-001	LTE-Advanced FDD Option (Requires MX269908A)	W3100AE	MX269013A Operation Manual (Operation)
MX269910A	LTE TDD IQproducer	W3101AE	MX269013A Operation Manual (Remote control)
MX269910A-001	LTE-Advanced TDD Option (Requires MX269910A)	W3031AE	MX269014A Operation Manual (Operation)
MX269911A	WLAN IQproducer	W3032AE	MX269014A Operation Manual (Remote control)
MX269911A-001	802.11ac (80 MHz) Option (Requires MX269911A)	W3044AE	MX269015A Operation Manual (Operation)
MX269912A	TD-SCDMA IQproducer	W3045AE	MX269015A Operation Manual (Remote control)
MX269913A	5G NR TDD sub-6 GHz IQproducer	W3305AE	MX269017A Operation Manual (Operation)
MX269914A	5G NR FDD sub-6 GHz IQproducer	W3306AE	MX269017A Operation Manual (Remote control)
	Warranty Service	W3014AE	MX269020A Operation Manual (Operation)
MS2690A-ES210	2 Years Extended Warranty Service	W3064AE	MX269020A Operation Manual (Remote control)
MS2690A-ES310	3 Years Extended Warranty Service	W3015AE	MX269021A Operation Manual (Operation)
MS2690A-ES510	5 Years Extended Warranty Service	W3065AE	MX269021A Operation Manual (Remote control)
MS2691A-ES210	2 Years Extended Warranty Service	W3209AE	MX269022A Operation Manual (Operation)
MS2691A-ES310	3 Years Extended Warranty Service	W3210AE	MX269022A Operation Manual (Remote control)
MS2691A-ES510	5 Years Extended Warranty Service	W3521AE	MX269023A Operation Manual (Operation)
MS2692A-ES210	2 Years Extended Warranty Service	W3522AE	MX269023A Operation Manual (Remote Control)
MS2692A-ES310	3 Years Extended Warranty Service	W3201AE	MX269024A Operation Manual (Operation)
MS2692A-ES510	5 Years Extended Warranty Service	W3202AE	MX269024A Operation Manual (Remote control)
	Application Parts	W3203AE	MX269026A Operation Manual (Operation)
W2850AE	Following operation manuals provided as hard copy MS2690A/MS2691A/MS2692A Operation Manual (Main frame Operation)	W3204AE	MX269026A Operation Manual (Remote control)
W2851AE	MS2690A/MS2691A/MS2692A and MS2830A/MS2840A/MS2850A Operation Manual (Main frame Remote Control)	W3528AE	MX269028A Operation Manual (Operation)
W2852AE	MS2690A/MS2691A/MS2692A Operation Manual (Signal Analyzer Function Operation)	W3529AE	MX269028A Operation Manual (Remote Control)
W2853AE	MS2690A/MS2691A/MS2692A and MS2830A/MS2840A/MS2850A Operation Manual (Signal Analyzer Function Remote Control)	W2860AE	MX269030A Operation Manual (Operation)
W2854AE	MS2690A/MS2691A/MS2692A and MS2830A/MS2840A/MS2850A Operation Manual (Spectrum Analyzer Function Operation)	W2861AE	MX269030A Operation Manual (Remote control)
W2855AE	MS2690A/MS2691A/MS2692A and MS2830A/MS2840A/MS2850A Operation Manual (Spectrum Analyzer Function Remote Control)	W3922AE	MX285051A/MX269051A Operation Manual
W2856AE	MS2690A/MS2691A/MS2692A-020 Operation Manual (Vector Signal Generator Option Operation)	W3963AE	MX285051A-011/MX269051A-011/MX285051A-021/ MX285051A-061/MX269051A-061/MX285051A-071 Operation Manual (Operation)
W2857AE	MS2690A/MS2691A/MS2692A-020 Operation Manual (Vector Signal Generator Option Remote Control)	W3964AE	MX285051A-011/MX269051A-011/MX285051A-021/ MX285051A-061/MX269051A-061/MX285051A-071 Operation Manual (Remote Control)
W2914AE	MS2690A/MS2691A/MS2692A and MS2830A/MS2840A Operation Manual (IQproducer for Vector Signal Generator Option)	W4035AE	MX285051A-031/MX269051A-031/MX285051A-081/ MX269051A-081 Operation Manual (Operation)
W2929AE	MS2690A/MS2691A/MS2692A and MS2830A/MS2840A Operation Manual (Standard Waveform Pattern for Vector Signal Generator Option)	W4036AE	MX285051A-031/MX269051A-031/MX285051A-081/ MX269051A-081 Operation Manual (Remote Control)
W3117AE	MS2690A/MS2691A/MS2692A and MS2830A/MS2840A/MS2850A Operation Manual (Phase Noise Measurement Function Operation)	W2915AE	MX269901A Operation Manual
W3118AE	MS2690A/MS2691A/MS2692A and MS2830A/MS2840A/MS2850A Operation Manual (Phase Noise Measurement Function Remote control)	W2916AE	MX269902A Operation Manual
W3655AE	MS2690A/MS2691A/MS2692A and MS2830A/MS2840A/MS2850A-017 Operation Manual (Noise Figure Measurement Function Operation)	W2917AE	MX269904A Operation Manual
W3656AE	MS2690A/MS2691A/MS2692A and MS2830A/MS2840A/MS2850A-017 Operation Manual (Noise Figure Measurement Function Remote Control)	W3023AE	MX269908A Operation Manual
		W3221AE	MX269910A Operation Manual
		W3488AE	MX269911A Operation Manual
		W3582AE	MX269912A Operation Manual
		W3984AE	MX269913A Operation Manual
		W4033AE	MX269914A Operation Manual

Ordering Information

Model/Order No.	Name
K240B	Power Divider (K connector, DC to 26.5 GHz, 50Ω, K-J, 1 W max.)
MA1612A	Four-Port Junction Pad (5 MHz to 3 GHz, N-J)
J0576B	Coaxial Cord (N-P · 5D-2W · N-P), 1 m
J0576D	Coaxial Cord (N-P · 5D-2W · N-P), 2 m
J0127A	Coaxial Cord (BNC-P · RG58A/U · BNC-P), 1 m
J0127B	Coaxial Cord (BNC-P · RG58A/U · BNC-P), 2 m
J0127C	Coaxial Cord (BNC-P · RG58A/U · BNC-P), 0.5 m
J0322A	Coaxial Cord (SMA-P · 50Ω SUCOFLEX104 · SMA-P), 0.5 m (DC to 18 GHz)
J0322B	Coaxial Cord (SMA-P · 50Ω SUCOFLEX104 · SMA-P), 1 m (DC to 18 GHz)
J0322C	Coaxial Cord (SMA-P · 50Ω SUCOFLEX104 · SMA-P), 1.5 m (DC to 18 GHz)
J0322D	Coaxial Cord (SMA-P · 50Ω SUCOFLEX104 · SMA-P), 2 m (DC to 18 GHz)
J0805	DC Block, N type (MODEL 7003) (10 kHz to 18 GHz, N-P · N-J)
J1555A	DC Block, SMA type (MODEL 7006-1) (9 kHz to 20 GHz, SMA-P · SMA-J)
K261	DC Block (10 kHz to 40 GHz, K-P · K-J)
J0004	Coaxial Adapter (DC to 12.4 GHz, 50Ω, N-P · SMA-J)
J1398A	N-SMA Adapter (DC to 26.5 GHz, 50Ω, N-P · SMA-J)
J0911	Coaxial Cord, 1.0 M (for 40 GHz) (DC to 40 GHz, approx. 1 m) (SF102A, 11K254/K254/1.0M)
J0912	Coaxial Cord, 0.5 M (for 40 GHz) (DC to 40 GHz, approx. 0.5 m) (SF102A, 11K254/K254/0.5M)
41KC-3	Fixed Attenuator, 3 dB (DC to 40 GHz, 3 dB)
J1750A	10 dB Fixed Attenuator (DC to 18 GHz, Input Power <20 W)
J1751A	20 dB Fixed Attenuator (DC to 18 GHz, Input Power <20 W)
J1752A	30 dB Fixed Attenuator (DC to 18 GHz, Input Power <20 W)
J1753A	3 dB Fixed Attenuator (DC to 18 GHz, Input Power <20 W)
J1754A	6 dB Fixed Attenuator (DC to 18 GHz, Input Power <20 W)
J1755A	Termination (50Ω, Type N, DC to 18 GHz)
J1261A	Ethernet Cable (Shield type, straight), 1 m
J1261B	Ethernet Cable (Shield type, straight), 3 m
J1261C	Ethernet Cable (Shield type, cross), 1 m
J1261D	Ethernet Cable (Shield type, cross), 3 m
J0008	GPIB Connection Cable, 2.0 m
J1373A*5	AUX Conversion Adapter (AUX → BNC, for vector signal generator option)
B0597A	Rack Mount Kit (EIA)
B0589A	Carrying Case (Hard type, with casters)
MA24105A	Inline Peak Power Sensor (350 MHz to 4 GHz, with USB A to mini B cable)
MA24106A	USB Power Sensor (50 MHz to 6 GHz, with USB A to mini B cable)
MA24108A	Microwave USB Power Sensor (10 MHz to 8 GHz, with USB A to Micro-B cable)
MA24118A	Microwave USB Power Sensor (10 MHz to 18 GHz, with USB A to Micro-B cable)
MA24126A	Microwave USB Power Sensor (10 MHz to 26 GHz, with USB A to Micro-B cable)
Z1037A	Installation Kit (required when retrofitting options or installing software)

*5: The AUX Conversion Adapter J1373A is not a standard accessory for the Vector Signal Generator Option MS269xA-020/120.



AUX Conversion Adapter
J1373A



USB Power Sensor
MA24106A



Carrying Case (Hard type)
B0589A

Trademarks:

- IQproducer™ is a registered trademark of Anritsu Corporation.
- MATLAB® is a registered trademark of The MathWorks, Inc.
- CDMA2000® is a registered trademark of the Telecommunications Industry Association (TIA-USA).
- The Bluetooth® mark and logos are owned by Bluetooth SIG, Inc. and are used by Anritsu under license.
- Pentium® is registered trademarks of Intel Corporation or its subsidiaries in the USA and other countries.
- Windows® is a registered trademark of Microsoft Corporation in the USA and other countries.
- CompactFlash® is a registered trademark of SanDisk Corporation in the United States and is licensed to CFA (Compact Flash Association).
- WiMAX® is a trademark or registered trademark of WiMAX Forum.
- Wi-Fi® is a registered trademark of Wi-Fi Alliance.
- Other companies, product names and service names are registered trademarks of their respective companies.

4TECT

OOO «4TECT»

Телефон: +7 (499) 685-4444

info@4test.ru

www.4test.ru